

SERVICE MANUAL

FE-2 CHASSIS

MODEL	COMMANDER	DEST	CHASSIS NO.	MODEL	COMMANDER	DEST	CHASSIS NO.
KV-21FX30B	RM-887	FR	SCC-Q54G-A	KV-21FX30K	RM-887	OIRT	SCC-Q51J-A
KV-21FX30E	RM-887	ESP	SCC-Q53H-A				

FD Trinitron



TRINITRON[®] COLOR TV
SONY[®]

TABLE OF CONTENTS

Section	Title	Page	Section	Title	Page
	Specifications	3	4. CIRCUIT ADJUSTMENTS		
	Connectors	4	4-1. Electrical Adjustments		19
	Self Diagnostic Software	5	4-2. Test Mode 1		21
1. GENERAL			4-3. Test Mode 2		21
	Switching On the TV and Automatically Tuning	6	5. DIAGRAMS		
	Introducing the Menu System	7	5-1. Block Diagrams (1)		23
	Menu Guide	7	Block Diagrams (2)		25
	Teletext	10	5-2. Circuit Board Location		26
	Specifications	11	5-3. Schematic Diagrams and Printed Wiring Boards		26
	Troubleshooting	11	* C Board		27
2. DISASSEMBLY			* A Board		29
2-1. Rear Cover Removal		12	5-4. Semiconductors		37
2-2. Speaker Disconnection		12	5-5. IC Blocks		39
2-3. Speaker Box Removal		12	6. EXPLODED VIEWS		
2-4. Speaker Box Disassembly		12	6-1. Chassis		40
2-5. A Board PWB Removal 1		13	6-2. Picture Tube		41
2-6. A Board PWB Removal 2		13	7. ELECTRICAL PARTS LIST		42
2-7. Service Position		13			
2-8. Wire Dressing		13			
2-9. Picture Tube Removal		14			
3. SET-UP ADJUSTMENTS					
3-1. Beam Landing		15			
3-2. Convergence		16			
3-3. Focus Adjustment		18			
3-4. Screen (G2), White Balance		18			

CAUTION

SHORT CIRCUIT THE ANODE OF THE PICTURE TUBE AND THE ANODE CAP TO THE METAL CHASSIS, CRT SHIELD, OR THE CARBON PAINTED ON THE CRT, AFTER REMOVAL OF THE ANODE CAP.

WARNING !!

AN ISOLATION TRANSFORMER SHOULD BE USED DURING ANY SERVICE WORK TO AVOID POSSIBLE SHOCK HAZARD DUE TO LIVE CHASSIS, THE CHASSIS OF THIS RECEIVER IS DIRECTLY CONNECTED TO THE POWER LINE.

SAFETY-RELATED COMPONENT WARNING !!

COMPONENTS IDENTIFIED BY SHADING AND MARKED Δ ON THE SCHEMATIC DIAGRAMS, EXPLODED VIEWS AND IN THE PARTS LIST ARE CRITICAL FOR SAFE OPERATION. REPLACE THESE COMPONENTS WITH SONY PARTS WHOSE PART NUMBERS APPEAR AS SHOWN IN THIS MANUAL OR IN SUPPLEMENTS PUBLISHED BY SONY.

ATTENTION

APRES AVOIR DECONNECTE LE CAP DE L'ANODE, COURT-CIRCUITER L'ANODE DU TUBE CATHODIQUE ET CELUI DE L'ANODE DU CAP AU CHASSIS METALLIQUE DE L'APPAREIL, OU AU COUCHE DE CARBONE PEINTE SUR LE TUBE CATHODIQUE OU AU BLINDAGE DU TUBE CATHODIQUE.

ATTENTION !!

AFIN D'EVITER TOUT RISQUE D'ELECTROCUTION PROVENANT D'UN CHÂSSIS SOUS TENTION, UN TRANSFORMATEUR D'ISOLEMENT DOIT ETRE UTILISÉ LORS DE TOUT DÉPANNAGE LE CHÂSSIS DE CE RÉCEPTEUR EST DIRECTMENT RACCORDÉ À L'ALIMENTATION SECTEUR.

ATTENTION AUX COMPOSANTS RELATIFS Á LA SECURITÉ!!

LES COMPOSANTS IDENTIFIÉS PAR UNE TRAME ET PAR UNE MARQUE Δ SUR LES SCHÉMAS DE PRINCIPE, LES VUES EXPLOSÉES ET LES LISTES DE PIÉCES SONT D'UNE IMPORTANCE CRITIQUE POUR LA SÉCURITÉ DU FONCTIONNEMENT, NE LES REMPLACER QUE PAR DES COMPSANTS SONY DONT LE NUMÉRO DE PIÉCE EST INDIQUÉ DANS LE PRÉSENT MANUEL OU DANS DES SUPPLÉMENTS PUBLIÉS PAR SONY.

ITEM MODEL	Television System	Stereo System	Channel Coverage	Color System
B	B/G/H, D/K, I, L	GERMAN/NICAM Stereo	VHF : E2-E12, F2-F10 UHF : E21-E69, F21-F69, B21-B69 CABLE TV : S01-S03, S1-S20, B-Q HYPER : S21-S41	PAL, SECAM NTSC4.43, NTSC3.58 (VIDEO IN)
E	B/G/H, D/K	GERMAN/NICAM Stereo	VHF : E2-E12 UHF : E21-E69 CABLE TV : S01-S03, S1-S20 HYPER : S21-S41	PAL, SECAM NTSC4.43, NTSC3.58 (VIDEO IN)
K	B/G/H, D/K	GERMAN/NICAM Stereo	VHF : E2-E12, R01-R12 UHF : E21-E69, R21-R69 CABLE TV : S01-S03, S1-S20 HYPER : S21-S41	PAL, SECAM NTSC4.43, NTSC3.58 (VIDEO IN)

Picture Tube	Flat Display FD Trinitron Approx 55 cm (21 inches) (Approx 51 cm picture measured diagonally)	Sound output	
		Right and Left speaker	2x14W (Music Power) 2x7W (RMS)
Input/Output Terminals [REAR]		General Specifications	
1: 21-pin Euro connector (CENELEC standard)	Inputs for Audio and Video signals. Inputs for RGB. Outputs of TV Video and Audio signals.	Power Requirements	220 - 240V
		Power Consumption	87 W
2: 21-pin Euro connector	Inputs for Audio and Video signals. Inputs for S Video. Outputs of TV Video and Audio signals. (selectable)	Dimensions	Approx 545x446x485 mm
		Weight	Approx 26kg
RCA Connectors	Variable Output for audio signals	Supplied Accessories	RM-887 Remote Commander (1) IEC designated R6 battery (2)
Input/Output Terminals [FRONT]		Other Features	TV system Autodetection, Teletext Smartlink
Headphone jack	stereo mini jack	Remote Control System : Infrared Control	
Audio inputs	phono jacks	Power requirements	3V dc 2 batteries IEC designation R6 (size AA)
Video inputs	phono jacks		
Design and specifications are subject to change without notice.			

Model Name Item	KV-21FX30B	KV-21FX30E	KV-21FX30K
Pal Comb	OFF	OFF	OFF
PIP	OFF	OFF	OFF
RGB Priority	ON	ON	ON
Woofers Box	OFF	OFF	OFF
Scart 1	ON	ON	ON
Scart 2	ON	ON	ON
Front in (3)	ON	ON	ON
Scart 4	OFF	OFF	OFF
Projector	OFF	OFF	OFF
Norm B/G	ON	ON	ON
Norm I	ON	OFF	OFF
Norm D/K	ON	ON	ON
Norm AUS	OFF	OFF	OFF
Norm L	ON	OFF	OFF
Norm SAT	OFF	OFF	OFF
Norm M	OFF	OFF	OFF
Teletext	ON	ON	ON
Nicam Stereo	ON	ON	ON

21 pin connector

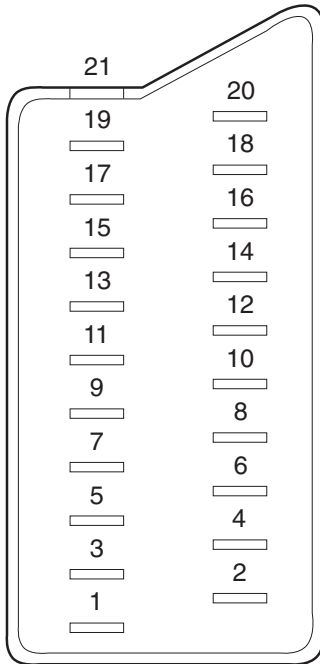

Pin No	1	2	4	Signal	Signal level
1	○	○	○	Audio output B (right)	Standard level : 0.5V rms Output impedance : Less than 1kohm*
2	○	○	○	Audio output B (right)	Standard level : 0.5V rms Output impedance : More than 10kohm*
3	○	○	○	Audio output A (left)	Standard level : 0.5V rms Output impedance : Less than 1kohm*
4	○	○	○	Ground (audio)	
5	○	○	○	Ground (blue)	
6	○	○	○	Audio input A (left)	Standard level : 0.5V rms Output impedance : More than 10kohm*
7	○	●	●	Blue input	0.7 +/- 3dB, 75 ohms positive
8	○	○	○	Function select (AV control)	High state (9.5-12V) : Part mode Low state (0-2V) : TV mode Input impedance : More than 10K ohms Input capacitance : Less than 2nF
9	○	○	○	Ground (green)	
10	○	○	○	Open	
11	○	●	●	Green	Green signal : 0.7 +/- 3dB, 75 ohms, positive
12	○	○	○	Open	
13	○	○	○	Ground (red)	
14	○	○	○	Ground (blinking)	
15	○	-	-	Red input	0.7 +/- 3dB, 75 ohms, positive
	-	○	○	(S signal Chroma input)	0.3 +/- 3dB, 75 ohms, positive
16	○	●	●	Blanking input (Ys signal)	High state (1-3V) Low state (0-0.4V) Input impedance : 75 ohms
17	○	○	○	Ground (video output)	
18	○	○	○	Ground (video input)	
19	○	○	○	Video output	1V +/- 3dB, 75ohms, positive sync 0.3V (-3+10dB)
20	○	-	-	Video input	1V +/- 3dB, 75ohms, positive sync 0.3V (-3+10dB)
	-	○	○	Video input Y (S signal)	1V +/- 3dB, 75ohms, positive sync 0.3V (-3+10dB)
21	○	○	○	Common ground (plug, shield)	

○ Connected ● Not Connected (open) * at 20Hz - 20kHz

Rear Connection Panel

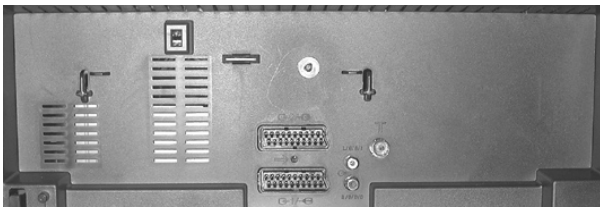

Front Connection Panel

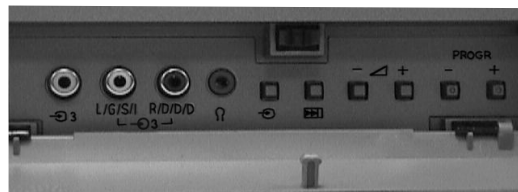

FE-2 SELF DIAGNOSTIC SOFTWARE

The identification of errors within the FE-2 chassis is triggered in one of two ways :- 1: Busy or 2: Device failure to respond to IIC. In the event of one of these situations arising the software will first try to release the bus if busy (Failure to do so will report with a continuous flashing LED) and then communicate with each device in turn to establish if a device is faulty. If a device is found to be faulty the relevant device number will be displayed through the LED (Series of flashes which must be counted) See table 1., non fatal errors are reported using this method. Each time the software detects an error it is stored within the NVM. See Table 2.

Table 1

Error Message	LED Code
No error	00
Reserved	01
OCP (Over Current Protection)	02
Not Used	03
No Vertical Sync	04
IKR Error at power on	05
IIC bus clock and/or data lines low at power on	06
NVM no IIC bus acknowledge at power on	07
Not Used	08
Tuner no acknowledge at power on	09
Sound Processor Error	10
Jungle controller 8 volts error	11

How to enter into Table 2

1. Turn on the main power switch of the TV set and enter into the 'Standby Mode'.
2. Press the following sequence of buttons on the Remote Commander.

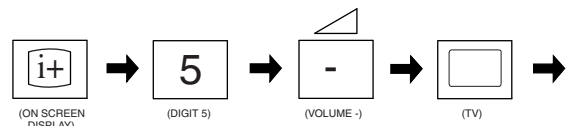

3. The following table will be displayed indicating the error count.

Flash Timing Example : e.g. error number 3

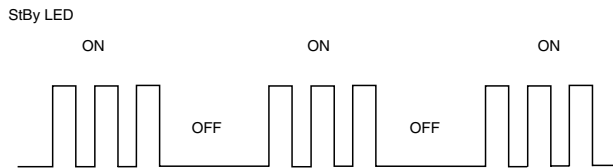

Table 2

ERROR MENU			
E02	OCP	(0, 255)	0
E03	OVP N/A	(0, 255)	0
E04	VSUNC	(0, 255)	0
E05	IKR	(0, 255)	0
E06	IIC	(0, 255)	0
E07	NVM	(0, 255)	0
E08	JUNGLE	(0, 255)	0
E09	TUNER	(0, 255)	0
E10	SOUNDP	(0, 255)	0
E11	8V	(0, 255)	0
WORKING TIME			
HOURS			2
MINUTES			11

Note: To clear the error count data press '80' on the Remote commander.

The operating instructions mentioned here are partial abstracts from the 'Operating Instruction Manual'. The page numbers of the 'Operating Instruction Manual' remain as in the manual.

Switching On the TV and Automatically Tuning

The first time you switch on your TV, a sequence of menu screens appear on the TV enabling you to: 1) choose the language of the menu screen, 2) choose the country in which you wish to operate the TV, 3) adjust the picture slant, 4) search and store all available channels (TV Broadcast) and 5) change the order in which the channels (TV Broadcast) appear on the screen.

However, if you need to change any of these settings, you can do that by selecting the appropriate option in the **Set Up** menu or by pressing the **Auto Start Up Button** on the TV set.

1 Connect the TV plug to the mains socket (220-240V AC, 50Hz)

Press the **On/Off** button on the TV set to turn on the TV. The first time you press this button, a **Language** menu displays automatically on the TV screen.

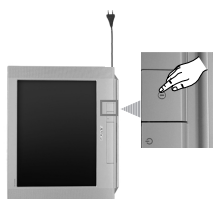

2 Press the **Up** or **Down** button on the remote control to select the language, then press the **OK** button to confirm your selection. From now on all the menus will appear in the selected language.

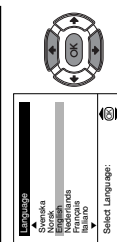

3 The **Country** menu appears automatically on the TV screen. Press the **Up** or **Down** button to select the country in which you will operate the TV set, then press the **OK** button to confirm your selection.

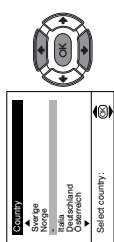

• If the country in which you want to use the TV set does not appear in the list, select **"/"** instead of a country.

• In order to avoid wrong teletext characters for Cyrillic languages we recommend to select Russia country in the case that your own country does not appear in the list.

4 Because of the earth's magnetism, the picture might slant. The **Picture Rotation** menu allows you to correct the picture slants if it is necessary.

a) If it is not necessary, press **Up** or **Down** to select **Not necessary** and press **OK**.

b) If it is necessary, press **Up** or **Down** to select **Adjust now**, then press **OK** and correct any slant of the picture between **-5** and **+5** by pressing **Up** or **Down**. Finally press **OK** to store.



5 The **Auto Tuning** menu appears on the screen. Press the **OK** button to select **Yes**.

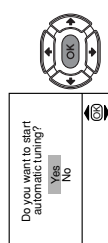

6 The TV starts to automatically search and store all available broadcast channels for you.

Warning: This procedure could take some minutes. Please be patient and do not press any button. Otherwise the automatic tuning will not be completed.

Warning: If no channels were found during the auto tuning process then a new menu appears automatically on the screen asking you to connect the aerial. Please connect the aerial (see page 6) and press **OK**. The auto tuning process will start again.

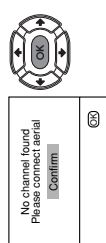
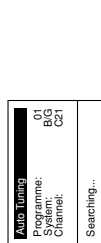

7 **Info:** After all available channels are captioned and stored, the **Programme Sorting** menu appears automatically on the screen enabling you to change the order in which the channels appear on the screen.

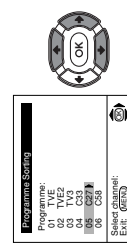

a) If you wish to keep the broadcast channels in the tuned order, go to step 8.

b) If you wish to store the channels in a different order: 1 Press the **Up** or **Down** button to select the programme number with the channel (TV Broadcast) you wish to rearrange, then press the **Up** button.

2 Press the **Up** or **Down** button to select the new programme number position for your selected channel (TV Broadcast), then press **Down**.

3 Repeat steps b)1 and b)2 if you wish to change the order of the other channels.

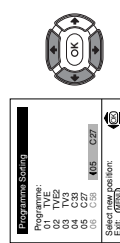

8 Press the **MENU** button to remove the menu from the screen.



Tip: Your TV is now ready for use

Introducing and Using the Menu System

Your TV uses an on-screen menu system to guide you through the operations. Use the following buttons on the Remote Control to operate the menu system:

1 Press the **MENU** button to switch the first level menu on.



2 To highlight the desired menu or option, press **↔** or **↕**.

- To enter to the selected menu or option, press **→**.
- To return to the last menu or option, press **←**.
- To alter settings of your selected option, press **↔** / **↕** or **↔** / **↕** or **↔**.
- To confirm and store your selection, press **OK**.



3 Press the **MENU** button to remove the menu from the screen.



GB

Menu Guide

Level 1

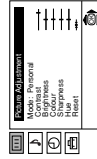

Level 2

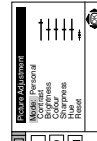

Level 3 / Function

PICTURE ADJUSTMENT

The "Picture Adjustment" menu allows you to alter the picture adjustments.

To do this: after selecting the item you want to alter press **↔**, then press repeatedly **↔** / **↕** or **↔** / **↕** to adjust it and finally press **OK** to store the new adjustment.

This menu also allows you to customise the picture mode based on the programme you are watching:

- **Personal** (for individual settings).
- **Live** (for live broadcast programmes).
- **Movie** (for films).

- **Brightness, Colour and Sharpness** can only be altered if "Personal" mode is selected.
- **Hue** is only available for NTSC colour signal (e.g. USA video tapes).
- Select **Reset** and press **OK** to reset the picture to the factory preset levels.

continued...

Level 1

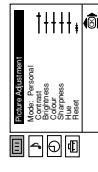

Level 2



Level 3 / Function

SOUND ADJUSTMENT

The "Sound Adjustment" menu allows you to alter the sound adjustments.

To do this: after selecting the item you want to alter, press **↔**, then press repeatedly **↔** / **↕** or **↔** / **↕** to adjust it and finally press **OK** to store the new adjustment.

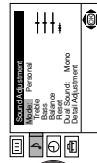

This menu also contains two submenus as following:

- **Mode**
 - **Personal** (for individual settings)
 - **Rock**
 - **Pop**
 - **Jazz**

- **Detail Adjustment**
 - **Off:** Normal.
 - **Spatial:** Acoustic sound effect.

- **Auto volume:**
 - **Off:** Volume channel changes according to the broadcast signal.
 - **On:** Volume level of the channels will stay the same, independent of the broadcast signal (e.g. in the case of advertisements).

- **TV Speakers:**
 - **Off:** Sound from external amplifier connected to the audio outputs on the rear of the TV set.
 - **On:** Sound from the TV set.

- **Treble and Bass** can only be altered if "Personal" mode is selected.
- Select **Reset** and press **OK** to reset the sound to the factory preset levels.
- In case of a bilingual broadcast select **Dual Sound** and set **A** for sound channel 1, **B** for sound channel 2 or **Mono** for mono channel if available. For a stereo broadcast you can choose **Stereo** or **Mono**.

continued...

Level 1

Level 2

Level 3 / Function

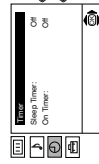
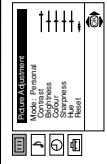

SLEEP TIMER

The "Sleep Timer" option in the "Timer" menu allows you to select a time period for the TV to switch itself automatically into the standby mode.

To do this: after selecting the option press **↵**, then press **↵** or **↵** to set the time period delay (max. of 4 hours) and finally press **OK** to store.

- While watching the TV, you can press the **⏻** button on the remote control to display the time remaining.
- One minute before the TV switches itself into standby mode, the time remaining is displayed on the TV screen automatically.

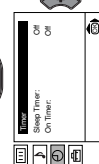
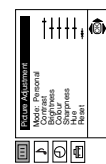

ON TIMER

The "On Timer" option in the "Timer" menu allows you to select a time period for the TV to switch itself automatically on from standby mode.

To do this: after selecting the option press **↵**, then press **↵** or **↵** to set the time period delay (max. 12 hours) and press **OK** to store. Finally press the standby button **⏻** on the remote control. After the selected length of time the TV switches on automatically.

- The standby indicator **⏻** on the TV set flashes regularly to indicate that "On Timer" is active.
- Any loss of power will cause these settings to be cleared.

A If you have not activated the "On Timer" option but the indicator **⏻** on the TV set flashes, please contact to your nearest Sony Service Centre.

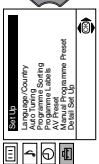

LANGUAGE / COUNTRY

The "Language/Country" option in the "Set Up" menu allows you to select the language that the menus are displayed in. It also allows you to select the country in which you wish to operate the TV set.

To do this: after selecting the option, press **↵** and then proceed in the same way as in the steps 2 and 3 of the section "Switching On the TV and Automatically Tuning".

Level 1

Level 2

Level 3 / Function

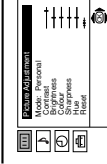

AUTO TUNING

The "Auto Tuning" option in the "Set Up" menu allows you to automatically search for and store all available TV channels.

To do this: after selecting the option, press **↵** and then proceed in the same way as in TV steps 5 and 6 of the section "Switching On the TV and Automatically Tuning".

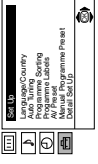
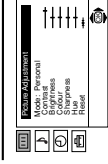

PROGRAMME SORTING

The "Programme Sorting" option in the "Set Up" menu allows you to change the order in which the channels (TV Broadcast) appear on the screen.

To do this: after selecting the option, press **↵** and then proceed in the same way as in step 7b) of the section "Switching On the TV and Automatically Tuning".

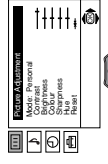

PROGRAMME LABELS

The "Programme Labels" option in the "Set Up" menu allows you to name a channel using up to five characters (letters or numbers).

- To do this:
- 1 After selecting the option, press **↵**, then press **↵** or **↵** to select the programme number with the channel you wish to name.
 - 2 Press **↵**. With the first element of the Label column highlighted, press **↵** or **↵** to select a letter or number (select "-" for a blank), then press **↵** to confirm this character. Select the other four characters in the same way. Finally press **OK** to store.

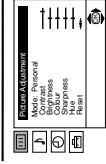

AV PRESET

The "AV Preset" option in the "Set Up" menu allows you to designate a name to the external equipment you have connected to the sockets of this TV.

- To do this:
- 1 After selecting the option, press **↵** then press **↵** or **↵** to select the input source you wish to name (AV1 and AV2 are for the rear Searis and AV3 for front connectors). Then press **↵**.

GB

continued...

continued...

Menu System

Level 1

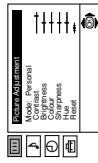

Level 3 / Function

b) Label a channel using up to five characters.

To do this: Highlighting the **Programme** option, press the **PROGR +/-** button to select the programme number with the channel you wish to name. When the programme you want to name appears on the screen, select the **Label** option and press **Next**. Press **Next** or **Left** to select a letter, number or **./_** for a blank. Press **Next** to confirm this character. Select the other four characters in the same way. After selecting all the characters, press **OK** twice to store.



Level 2

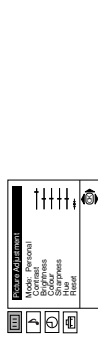

c) Normally the automatic fine tuning (AFT) is operating, however you can manually fine tune the TV to obtain a better picture reception in the case that the picture is distorted.

To do this: while watching the channel (TV Broadcast) you wish to fine tune, select the **AFT** option and press **Next**. Press **Next** or **Left** to adjust the fine tuning between -15 and +15. Finally press **OK** twice to store.

d) Skip any unwanted programme numbers when they are selected with the **PROGR +/-** buttons.

To do this: Highlighting the **Programme** option, press the **PROGR +/-** button to select the programme number you want to skip. When the programme you want to skip appears on the screen, select the **Skip** option and press **Next**. Press **Next** or **Left** to select **Yes**. Finally press **OK** twice to confirm and store.

To cancel this function afterwards, select "No" instead of "Yes" in the step above.

e) This option allows you to view and record correctly scrambling channels when using a decoder connected to the Scart **2/4** directly or through a VCR.

i This option is only available depending on the country you have selected in the "Language/Country" menu.

To do this: select the **Decoder** option and press **Next**. Press **Next** or **Left** to select **On**. Finally press **OK** twice to confirm and store.

To cancel this function afterwards, select "Off" instead of "On" in the step above.

continued...

Level 1

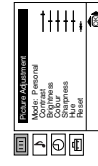

Level 2

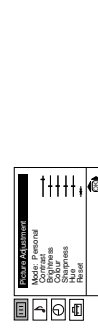

Level 3 / Function

NOISE REDUCTION

The "Noise Reduction" option in the "Detail Set Up" menu allows to reduce automatically the picture noise in case of a weak broadcasting signal.

To do this: after selecting the option, press **Next**. Then press **Next** or **Left** to select **Auto**. Finally press **OK** to confirm and store.

To cancel this function afterwards, select "Off" instead of "Auto" in the step above.



AV2 OUTPUT

The "AV2 Output" option in the "Detail Set Up" menu allows you to select the source to be output from the Scart connector **2/4** in order you can record from this Scart any signal coming from the TV or from an external equipment connected to the Scart connector **2/1/4** or front connectors **3** and **3**.

i If your VCR supports Smartlink, this procedure is not necessary.

To do this: after selecting the option, press **Next**. Then press **Next** or **Left** to select the desired output signal: **TV, AV1, AV3** or **AUTO**.

A If you select "AUTO", the output signal will always be the same one that is displayed on the screen.

A If you have connected a decoder to the Scart **2/4** or to a VCR connected to this Scart, please remember to change back the "AV2 Output" to "AUTO" or "TV" for a correct unscrambling.

continued...

Level 1

Level 2

Level 3 / Function

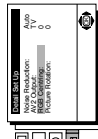
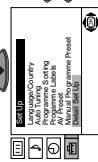
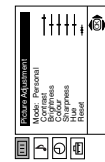

When connecting an RGB source, such as a "PlayStation", you may need to readjust the horizontal position of the picture. In that case, you can readjust it through the "RGB Centring" option in the "Detail Set Up".

To do this: while watching an RGB source select the "RGB Centring" option and press **↔**. Then press **↘** or **↙** to adjust the centre of the picture between -10 and +10. Finally press **OK** to confirm and store.

PICTURE ROTATION

Because of the earth's magnetism, the picture might slant. In this case, you can correct the pictures slant by using the option "Picture Rotation" in the "Detail Set Up" menu.

To do this: after selecting the option, press **↔**. Then press **↘** or **↙** to correct any slant of the picture between -5 and +5 and finally press **OK** to store.

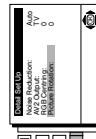
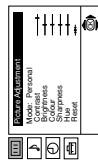

Teletext

i Teletext is an information service transmitted by most TV stations. The index page of the teletext service (usually page 100) gives you information on how to use the service. To operate teletext, use the remote control buttons as indicated below.

A Make sure to use a channel (TV Broadcast) with a strong signal, otherwise teletext errors may occur.

To Switch On Teletext:

After select the TV channel which carries the teletext you wish to view, press **⏏**.



To Select a Teletext page:

Input 3 digits for the page number, using the numbered buttons.

- If you have made a mistake, retype the correct page number.
- If the counter on the screen continues searching, it is because this page is not available. In that case, input another page number

To access the next or preceding page:

Press **PROGR + (⏏)** or **PROGR - (⏏)**.

To superimpose teletext on to the TV:

Whilst you are viewing teletext, press **⏏**. Press it again to cancel teletext mode.

To freeze a teletext page:

Some teletext pages have sub-pages which follow on automatically. To stop them, press **⏏**/**⏏**. Press it again to cancel the freeze.

To reveal concealed information (e.g. answer to a quiz):

Press **⏏**/**⏏**. Press it again to conceal the information.

To Switch Off Teletext:

Press **⏏**.

GB

Fastext

i Fastext service lets you access pages with one button push.

While you are in Teletext mode and Fastext is broadcast, a colour coded menu appears at the bottom of the teletext page. Press the colour button (red, green, yellow or blue) to access the corresponding page.

Specifications

TV system:

Depending on your country selection:
B/G/H/D/K

Colour system:

PAL, SECAM

NTSC 3.58, 4.43 (only Video In)

Channel Coverage:

VHF: E2-E12

UHF: E21-E69

CATV: S1-S20

HYPER: S21-S41

D/K: R1-R12, R21-R69

Picture Tube:

Flat Display FD Trinitron

21" (approx. 55 cm, measured

diagonally)

Rear Terminals

☞1/☞

21-pin scart connector (CENELEC standard) including audio / video input, RGB input, TV audio / video output.

☞2/☞

21-pin Scart connector (CENELEC standard) including audio / video input, 5 video input, selectable audio / video output and Smartlink interface.

☞

audio outputs (Left / Right) - phono jacks

Front Terminals

☞3 video input - phono jack

☞3 audio input - phono jacks

☞ headphones jack

Design and specifications are subject to change without notice.

Ecological Paper - Totally Chlorine Free ♻️

Troubleshooting

Here are some simple solutions to the problems which may affect the picture and sound.

Problem	Solution
No picture (screen is dark) and no sound.	<ul style="list-style-type: none"> Check the aerial connection. Plug the TV in and press the ⏻ button on the front of the TV. If the standby indicator ⏻ is on, press I/⏻ button on the remote control.
Poor or no picture (screen is dark), but good sound.	<ul style="list-style-type: none"> Using the menu system, select the "Picture Adjustment" menu and select "Reset" to return to the factory settings.
No picture or no menu information from equipment connected to the Scart connector.	<ul style="list-style-type: none"> Check that the optional equipment is on and press the ⏻ button repeatedly on the remote control until the correct input symbol is displayed on the screen.
Good picture, no sound.	<ul style="list-style-type: none"> Press the ⏻ +/- button on the remote control. Check that "TV Speakers" is "On" on the "Sound Adjustment" menu. Check that headphones are not connected.
No colour on colour programmes.	<ul style="list-style-type: none"> Using the menu system, select the "Picture Adjustment" menu and select "Reset" to return to factory settings.
Distorted picture when changing programmes or selecting teletext.	<ul style="list-style-type: none"> Turn off any equipment connected to the Scart connector on the rear of the TV.
Wrong characters appear when viewing teletext.	<ul style="list-style-type: none"> Using the menu system, enter to the "Language/Country" menu and select the country in which you operate the TV set. For Cyrillic languages, we agree to select Russia country in the case that your own country does not appear in the list.
Picture slanted	<ul style="list-style-type: none"> Using the menu system, select the "Picture Rotation" option in the "Detail Set Up" menu to correct the picture slant.
Noisy picture when viewing a TV channel.	<ul style="list-style-type: none"> Using the menu system, select the "Manual Programme Preset" menu and adjust Fine Tuning (AFT) to obtain better picture reception. Using the menu system, select the "Noise Reduction" option in the "Detail Set Up" menu and select "Auto" to reduce the noise in the picture.
No unscrambling or unstable picture whilst viewing a scrambling channel with a decoder connected through the Scart connector ☞2/☞.	<ul style="list-style-type: none"> Using the menu system, select the "Set Up" menu. Then enter to "Detail Set Up" option and set "AV2 Output" to "TV".
Remote control does not function.	<ul style="list-style-type: none"> Replace the batteries.
The standby indicator ⏻ on the TV flashes even though the "On Timer" is set.	<ul style="list-style-type: none"> Contact to your nearest Sony service centre.

A In case of problems, have your TV serviced by qualified personnel. Never open the casing yourself.

GB

SECTION 2 DISASSEMBLY

2-1. Rear Cover Removal

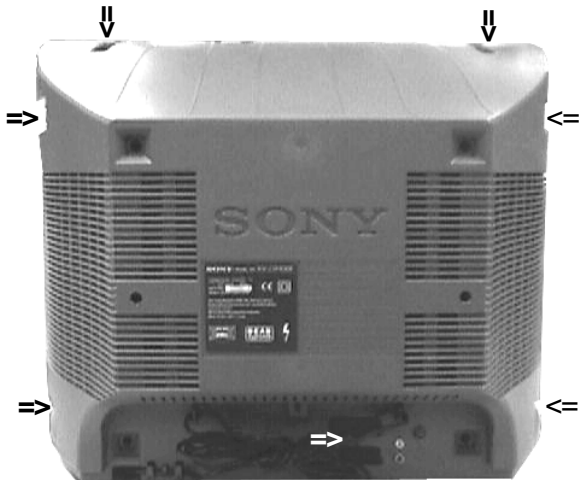

Release the mains power cable from its securing posts. Remove the rear cover fixing screws indicated. Pull the rear cover away from the front beznet. Take care when removing the rear cover not to damage the speaker cables as speakers are fitted inside the rear cover.

2-2. Speaker Connector Disconnection

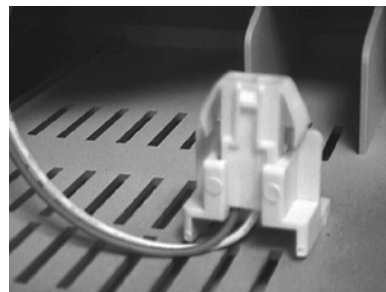
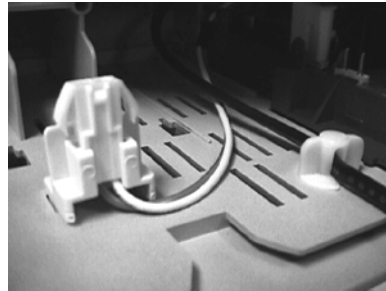

Before completely removing the rear cover disconnect the speaker connectors which are located on the inside base of the beznet.

2-3. Speaker Box Removal

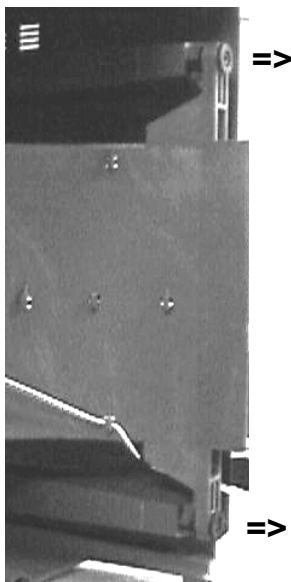

To remove the speaker box pull forward in the direction of the arrows while holding the rear cover. Ensure the weight is supported as the box is pulled from its mountings.

2-4. Speaker Box Disassembly

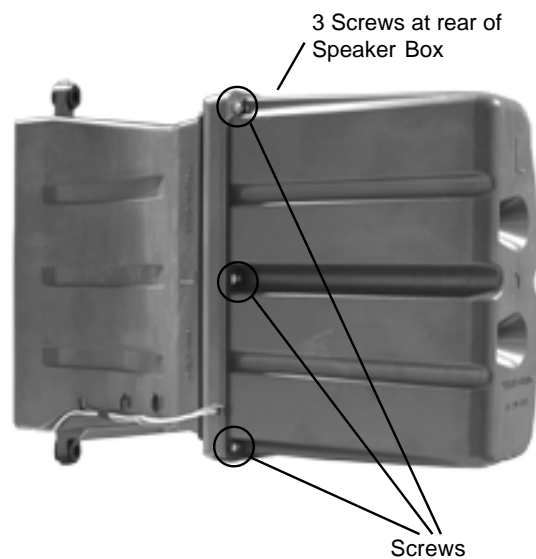

To gain access to the speaker remove the six screws and pull the two halves of the speaker box apart.

2-5. A Board PWB Removal [Step 1]

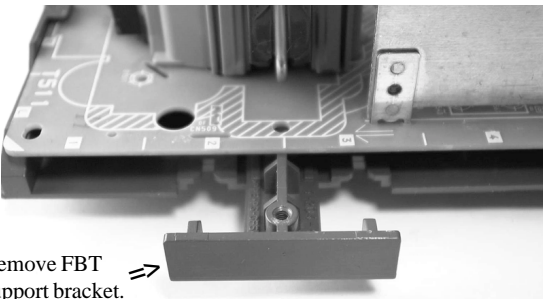
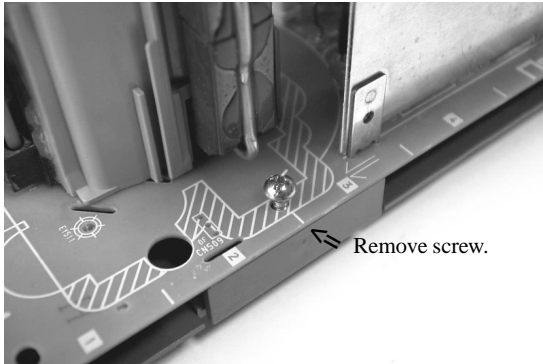

2-6. A Board PWB Removal [Step 2]

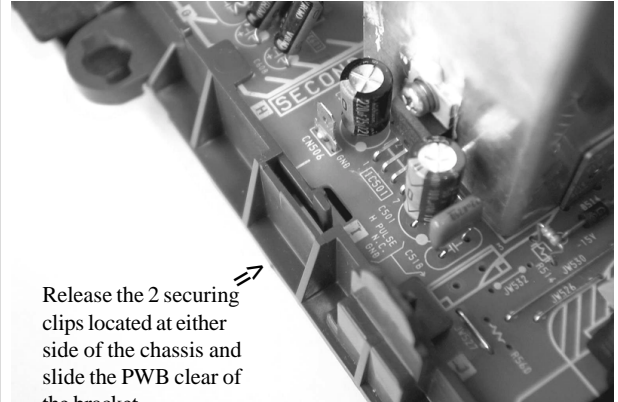

2-7. Service Position

Place the A Board PWB in the position indicated to carry out servicing.

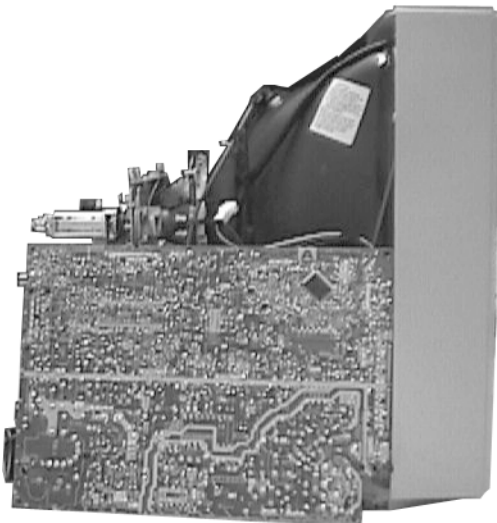

2-8. Wire Dressing

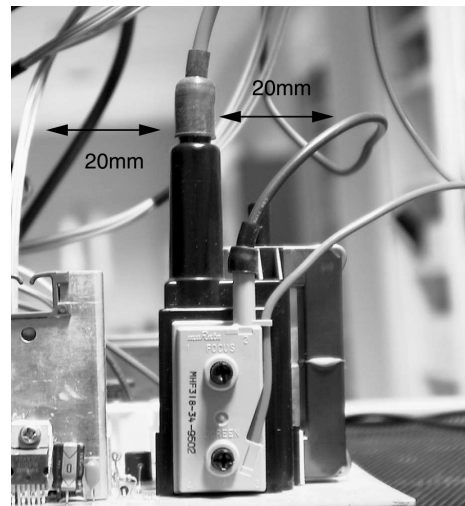

Ensure that all wires do not touch heat-sinks and high temperature hot spots. All wires must be kept at a minimum distance of 20mm away from the EHT lead.

2-9. Picture Tube Removal

WARNING: BEFORE REMOVING THE ANODE CAP

High voltage remains in the CRT even after the power is disconnected. To avoid electric shock, discharge CRT *before* attempting to remove the anode cap. Short between anode and CRT coated earth ground strap.

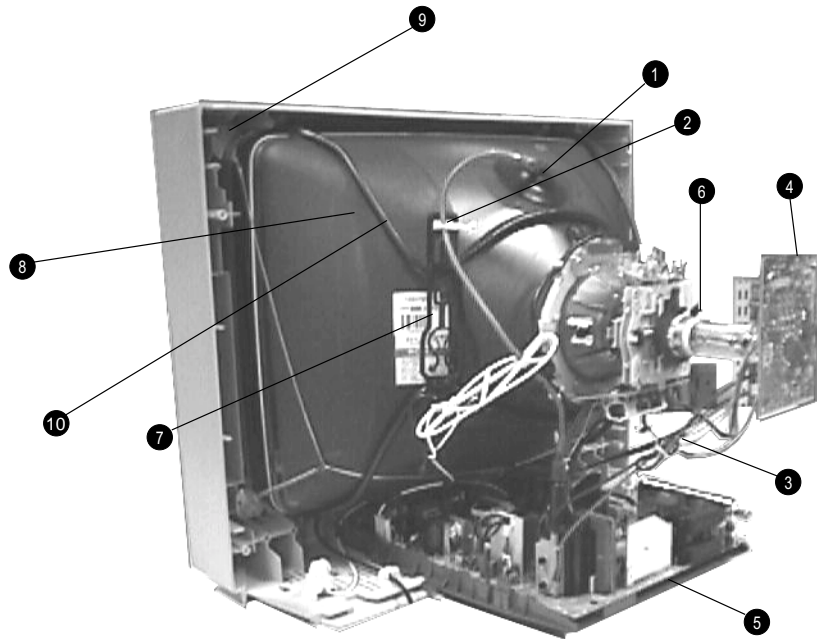
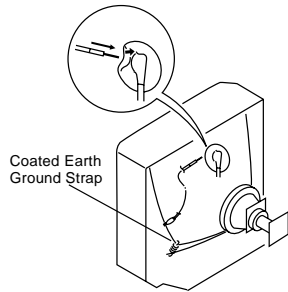

1. Discharge the anode of the CRT and remove the anode cap.
2. Release the EHT lead from its CRT support bracket.
3. Unplug all interconnecting leads from the Deflection yoke, degaussing coils and CRT grounding strap.
4. Remove the C Board from the CRT.
5. Remove the chassis assembly.
6. Loosen the Deflection yoke fixing screw and remove.
7. Remove the Degaussing Coil holders.
8. Place the set with the CRT face down on a cushion.
9. Unscrew the four CRT fixing screws [located on each CRT corner] and remove the CRT.
10. Remove the Degaussing Coils.
Remove the CRT grounding strap and spring tentioners.
[Take care not to handle the CRT by the neck.]

Removal of the Anode-Cap

* REMOVING PROCEDURES.

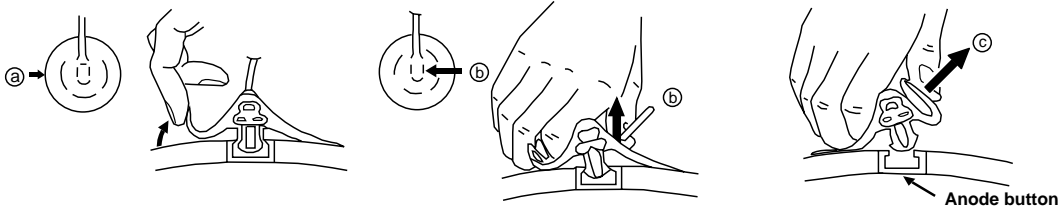

- ① Turn up one side of the rubber cap in the direction indicated by the arrow (a)
- ② Using a thumb pull up the rubber cap firmly in the direction indicated by the arrow (b)
- ③ When one side of the rubber cap is separated from the anode button, the anode-cap can be removed by turning up the rubber cap and pulling it up in the direction of the arrow (c)

How to handle the Anode-Cap

1. To prevent damaging the surface of the anode-cap do not use sharp materials.
2. Do not apply too great a pressure on the rubber, as this may cause damage to the anode connector.
3. A metal fitting called a shatter hook terminal is fitted inside the rubber cap.
4. Do not turn the rubber foot over excessively, this may cause damage if the shatter hook sticks out.

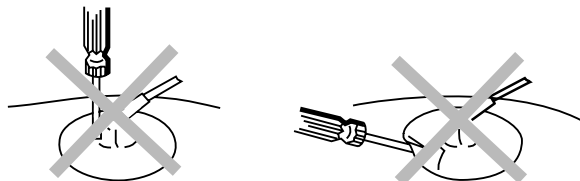

SECTION 3 SET-UP ADJUSTMENTS

- When complete readjustment is necessary or a new picture tube is installed, carry out the following adjustments.
- Unless there are specific instructions to the contrary, carry out these adjustments with the rated power supply.
- Unless there are specific instructions to the contrary, set the controls and switches to the following settings :

Contrast 80% [or remote control normal]

Brightness 50%

Carry out the adjustments in the following order :

- 3-1. Beam Landing.
- 3-2. Convergence.
- 3-3. Focus.
- 3-4. White Balance.

Note :

1. Test equipment required.
1. Color bar/pattern generator.
2. Degausser.
3. Oscilloscope.
4. Digital multimeter.

Preparation:

1. In order to reduce the influence of geomagnetism on the set's picture tube, face it in an easterly or westerly direction.
2. Switch on the set's power and degauss with the degausser.

3-1. Beam Landing

1. Input an all white signal from the pattern generator. Set the Contrast and Brightness to normal.
2. Set the pattern generator raster signal to Red.
3. Move the deflection yoke forward and adjust with the purity control so that the Red is at the centre and the Blue and Green take up equally sized areas on each side of the screen. [See Fig.3-1 - 3-3].
4. Move the deflection yoke backwards and adjust so that the entire screen becomes Red. [See Fig.3-1]
5. Switch the raster signal to Blue, then to Green and verify the condition.
6. When the position of the deflection yoke has been determined, fasten the deflection yoke with the screws.
7. If the beam does not land correctly in all the corners, use a magnet to correct it. [See Fig.3-4]

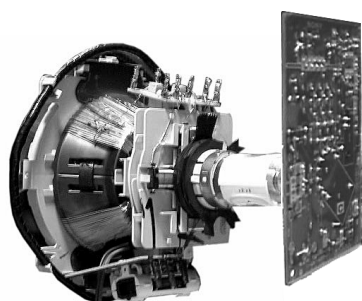

Fig. 3-1.

Caution :

High voltages are present on the Deflection yoke terminals - take care when handling the Deflection yoke whilst carrying out adjustments.

Fig. 3-2.

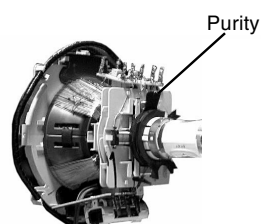

Fig. 3-3.

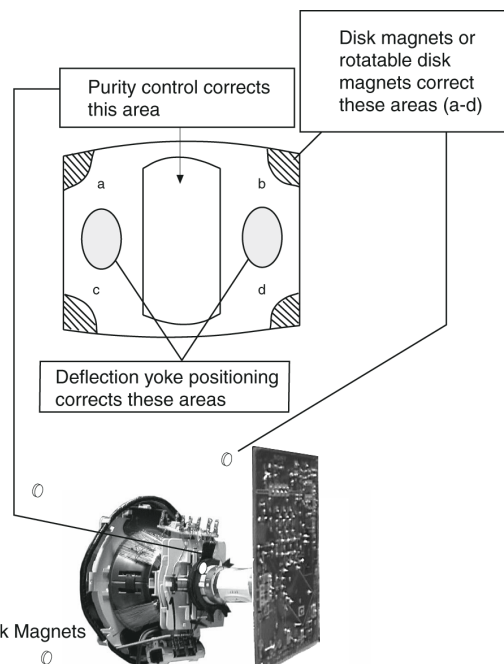
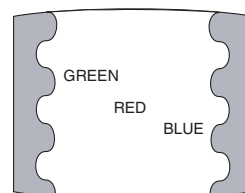

Fig.3-4

3-2. Convergence

Preparation:

- Before starting this adjustment, adjust the focus, horizontal size and vertical size.
- Minimize the Brightness setting.
- Input a dot pattern from the pattern generator.

Horizontal and Vertical Static Convergence

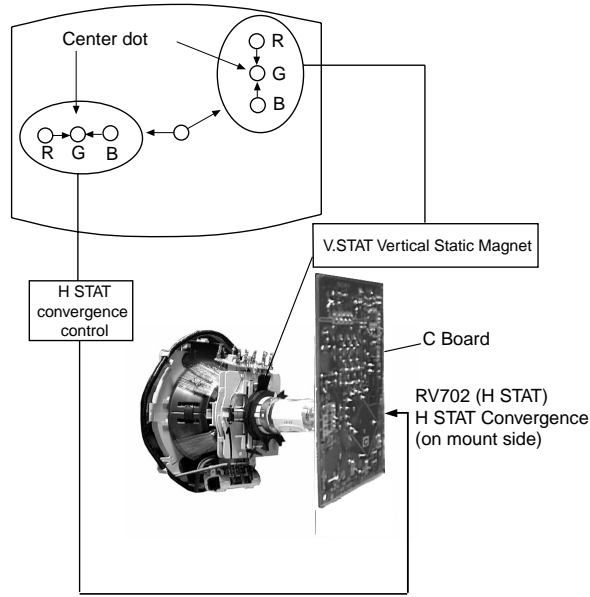
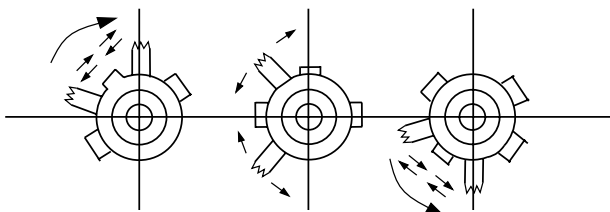

Fig.3-5

1. [Moving horizontally], adjust the H.STAT control so that the Red, Green and Blue points are on top of each other at the centre of the screen.
2. [Moving vertically], adjust the V.STAT magnet so that the Red, Green and Blue points are on top of each other at the centre of the screen.
3. If the H.STAT variable resistor is unable to bring the Red, Green and Blue points together at the centre of the screen, adjust the horizontal convergence with the H.STAT variable resistor and the V.STAT magnet in the manner indicated below.

[In this case, the H.STAT variable resistor and the V.STAT magnet influence each other].

- Tilt the V.STAT magnet and adjust the static convergence by opening or closing the V.STAT magnet.



4. If the V.STAT magnet is moved in the direction of the (a) and (b) arrows, the Red, Green and Blue points move as indicated below.

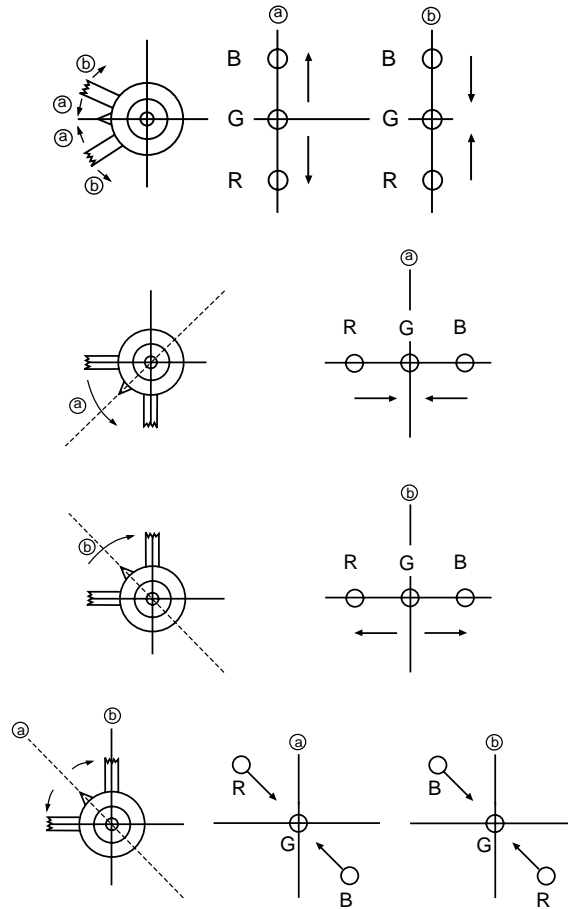

Operation of the BMC (Hexapole) magnet.

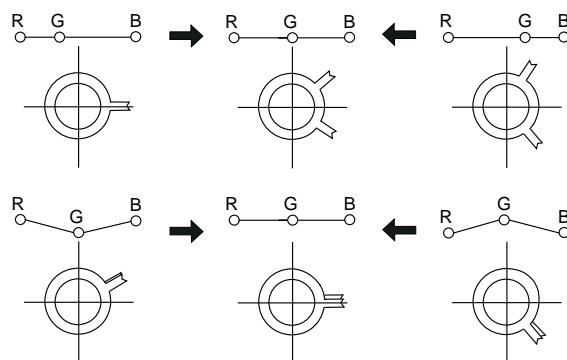

The movement of the magnets interact with each other and so the respective dot position should be monitored while carrying out this adjustment.

Use the H.STAT VR to adjust the Red, Green and Blue dots so that they coincide at the centre of the screen (by moving the dots in the horizontal direction).

Geometry Adjustment.

Preparation:

Before starting this adjustment, adjust the horizontal and vertical static convergence.

1. Remove the deflection yoke spacer.
2. Tilt the deflection yoke as indicated in the figure below and optimise the geometry.
Tilting the DY Up and Down will balance the upper and lower pin adjustment.
Tilting the DY Left and Right will balance the H-Trap adjustment.
3. Re-install the deflection yoke spacer.

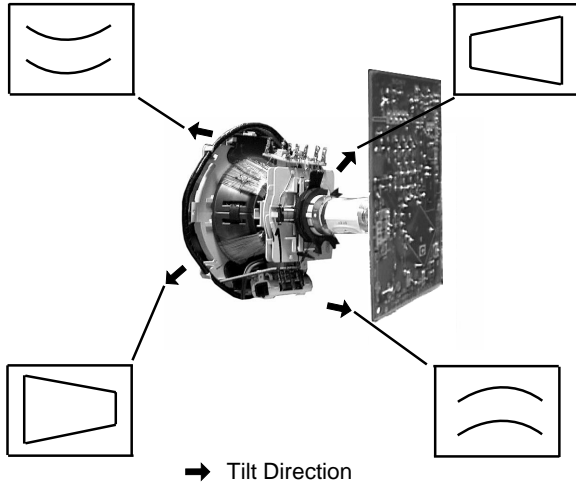

YCH Adjustment



TLV Adjustment

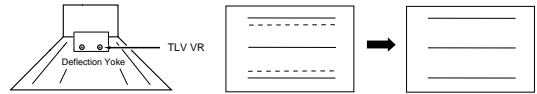

Screen Corner Convergence

If you are unable to adjust the corner convergence properly, this can be corrected with the use of permalloy magnets.

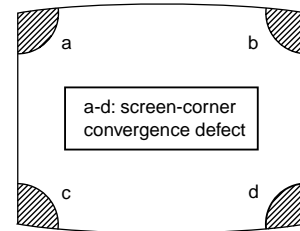

HTIL Adjustment

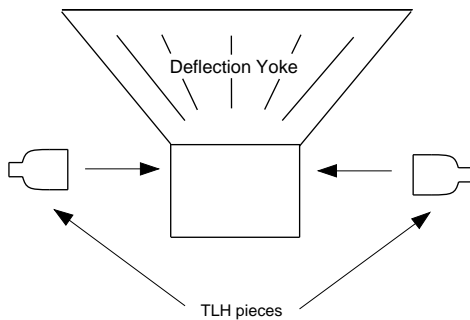

HTIL correction can be performed by adding a TLH correction assembly to the Deflection yoke.

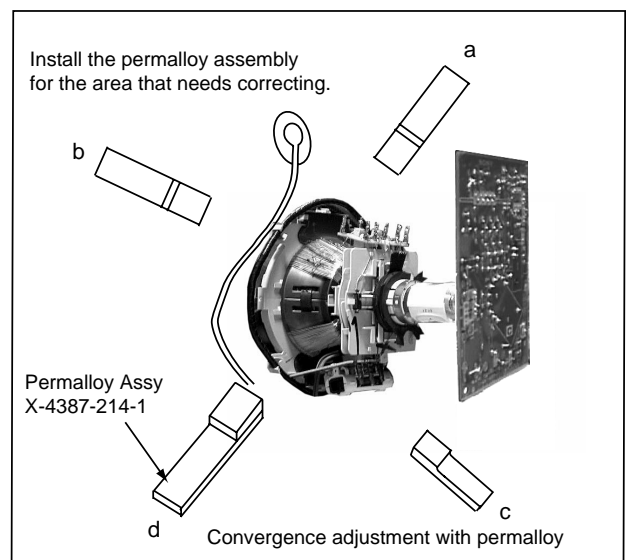
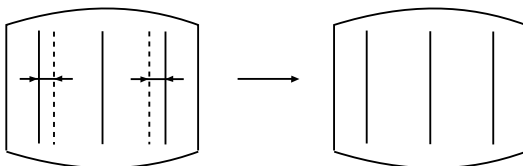

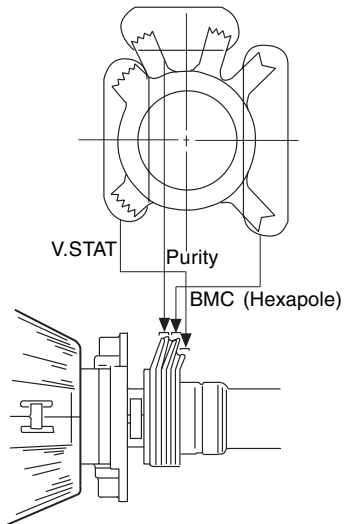

3-3. Focus Adjustment

1. Receive a television broadcast signal.
2. Normalize the picture setting.
3. Adjust the focus control located on the flyback transformer to obtain the best focus at the centre of the screen. Bring only the centre area of the screen into focus, the magenta-ring appears on the screen. In this case, adjust the focus to optimize the screen uniformly.

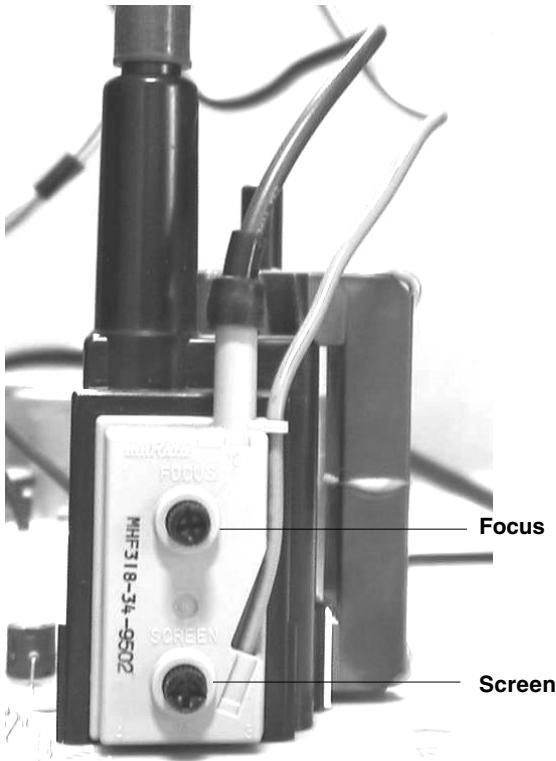

3-4. Screen (G2), White Balance

[Adjustment in the service mode using the remote commander]

G2 adjustment

1. Input a dot signal from the pattern generator.
2. Set the Picture, Brightness and Colour to minimum.
3. Apply 175V DC from an external power supply to the R, G and B cathodes of the CRT.
4. Whilst watching the picture, adjust the G2 control [SCREEN] located on the Flyback Transformer to the point just before the flyback return lines disappear.

White balance adjustment for TV mode

1. Input an all-white signal from the pattern generator.
2. Enter into the 'Service Mode' by pressing 'TEST', 'TEST' and 'MENU' on the Service Commander.
3. Select 'Service' from the on screen menu display and press the right arrow button on the remote commander.
4. The 'Service' menu will appear on the screen. [See Page 19]
5. Set the 'Contrast' to MAX.
6. Set the 'R-Drive' to 25.
7. Adjust the 'G-Drive' and the 'B-Drive' so that the white balance becomes optimum.
8. Press the 'OK' button to write the data for each item.
9. Set the 'Contrast' to MIN.
10. Adjust the 'G-Cutoff', and the 'R-Cutoff' with the left and right buttons on the remote commander so that the white balance becomes optimum.
11. Press the 'OK' button to write the data for each item.

SECTION 4 CIRCUIT ADJUSTMENTS

4-1. Electrical Adjustments

Service adjustments to this model can be performed using the supplied remote Commander RM-887.

How to enter into the Service Mode

- Turn on the main power switch and enter into the stand-by mode.
- Press the following sequence of buttons on the Remote Commander.

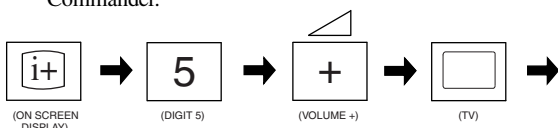

'TT—' will appear in the upper right corner of the screen. Other status information will also be displayed.

- Press 'MENU' on the remote commander to obtain the following menu on the screen.

Geometry	
Service	
Design	
Status	
Sound	
IF adjust	
Error Menu	
FE-2 Stereo v1.30	
Factory data FFh FFh	
MSP Device : MSP3411G	

- Move to the corresponding adjustment item using the up or down arrow buttons on the Remote Commander.
- Press the right arrow button to enter into the required menu item.
- Press the 'Menu' button on the Remote Commander to quit the Service Mode when all adjustments have been completed.

Note :

- Before performing any adjustments ensure that the correct model has been selected in the 'Model Setting' menu.
- After carrying out the service adjustments, to prevent the customer accessing the 'Service Menu' switch the TV set OFF and then ON.

ERROR MENU

E02	OCP	(0, 255)	0
E03	OVP N/A	(0, 255)	0
E04	VSUNC	(0, 255)	0
E05	IKR	(0, 255)	0
E06	IIC	(0, 255)	0
E07	NVM	(0, 255)	0
E08	JUNGLE	(0, 255)	0
E09	TUNER	(0, 255)	0
E10	SOUNDP	(0, 255)	0
E11	8V	(0, 255)	0

WORKING TIME

HOURS	2
MINUTES	11

SERVICE

Offset-R	(0, 63)	Adj
Offset-G	(0, 63)	Adj
R-Drive	(0, 63)	25
G-Drive	(0, 63)	Adj
B-Drive	(0, 63)	Adj
Peak-Freq	(0, 3)	0
Luma-Delay	(0, 15)	8
SC0	(0, 3)	2
White-Peak	(0, 15)	15
Subcont	(0, 15)	4
Subright	(0, 63)	31
Subcol	(0, 63)	Adj
Subsharp	(0, 63)	31
Cutoff Br.	(0, 63)	60
Br OSD	(0, 15)	10
Br TXT	(0, 15)	9

GEOMETRY

V-Linearity	(0, 63)	Adj
V-Scroll	(0, 63)	32
Left-HBlk	(0, 15)	8
Right-HBlk	(0, 15)	6
V-Angle	(0, 63)	Adj
V-Bow	(0, 63)	Adj
H-Centre	(0, 63)	Adj
H-Size	(0, 63)	Adj
Pin-Amp	(0, 63)	Adj
U-Corner-Pin	(0, 63)	Adj
L-Corner-Pin	(0, 63)	Adj
Pin Phase	(0, 63)	Adj
V-Slope	(0, 63)	35
V-Size	(0, 63)	Adj
S-Correction	(0, 63)	Adj
V-Centre	(0, 63)	Adj
V-Zoom	(0, 63)	23
Magenta	(0, 63)	40

IF ADJUST

AGC Adjust	(-16, +15)	+0
Automute		1
Audio Gain		0
L Gating		0

Sub Brightness Adjustment

- Input a Monoscope pattern.
- Press 'TEST' 'TEST' 13 on the Remote Commander.
- Adjust the 'Sub-Brightness' data so that there is barely a difference between the 0 IRE and 10 IRE signal levels.

Sub Contrast Adjustment

- Input a video signal that contains a small 100% white area on a black background.
- Connect an digital voltmeter to Pin 10 of J701 [C Board].
- Adjust the Sub-Contrast ['TT11'] to obtain a voltage of 95 +/-5V.

Sub Colour Adjustment

1. Receive a PAL colour bar signal.
2. Connect an oscilloscope to Pin 5 of CN003 [A Board].
3. Enter into the 'Service' service menu.
4. Adjust the 'Sub Colour' data so that the Cyan, Magenta and Blue colour bars are of equal levels as indicated below.

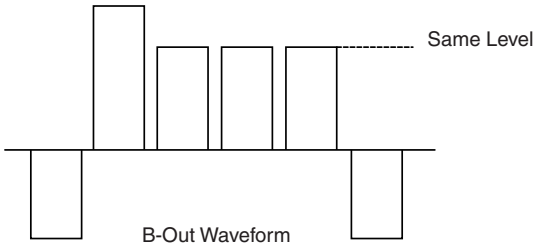

Tuner AGC Adjustment

Note:

There should be no need to adjust the AGC as this is pre-adjusted during manufacture of the FRONTEND. If the AGC does need adjustment then follow steps 1. to 4. below.

1. Receive a signal of 62dBuV / 75 ohm terminated via the tuner antenna socket.
2. Connect a voltmeter to pin1 of TU101 [print side of A Board] or to the AGC pin of CN001 [mount side of A Board].
3. Confirm that the AGC voltage is 3.5volts +/- 0.3volts.
4. If adjustment is required, then re-adjust the AGC variable resistor (located at the top rear of the FRONTEND) to obtain a voltage of 3.5V +/- 0.3V.

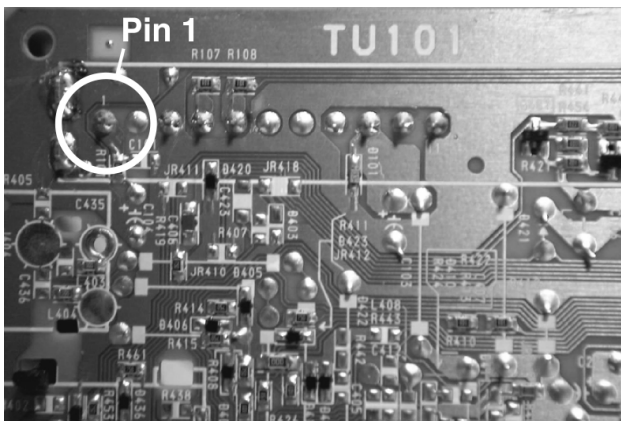

[Print side of A board]

Deflection System Adjustment

1. Enter into the 'Geometry' service menu.
2. Select and adjust each item in order to obtain the optimum image.

GEOMETRY		
V-Linearity	(0, 63)	Adj
V-Scroll	(0, 63)	32
Left-HBlk	(0, 15)	8
Right-HBlk	(0, 15)	6
V-Angle	(0, 63)	Adj
V-Bow	(0, 63)	Adj
H-Centre	(0, 63)	Adj
H-Size	(0, 63)	Adj
Pin-Amp	(0, 63)	Adj
U-Corner-Pin	(0, 63)	Adj
L-Corner-Pin	(0, 63)	Adj
Pin Phase	(0, 63)	Adj
V-Slope	(0, 63)	35
V-Size	(0, 63)	Adj
S-Correction	(0, 63)	Adj
V-Centre	(0, 63)	Adj
V-Zoom	(0, 63)	23
Magenta	(0, 63)	40

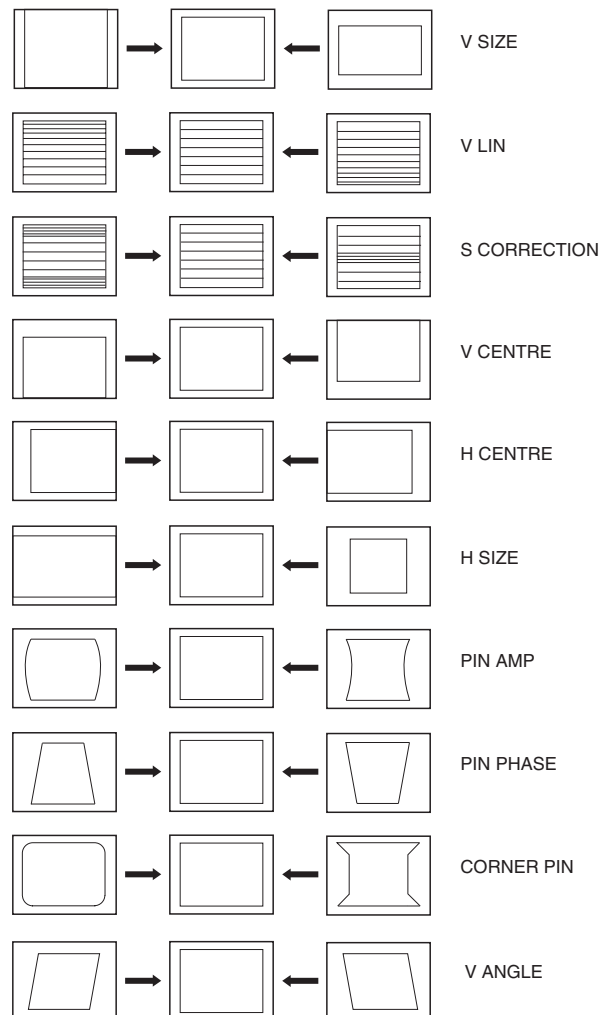

4-2. TEST MODE 1:

Test Mode 1 is available by pressing the 'TEST' button once, OSD 'T' appears. The functions described below are available by selecting the indicated keys. The 'T' is released automatically after each command is executed.

KEY	T-MODE FUNCTION
volume +	volume maximum
volume -	Picture minimum
picture +	Picture maximum
picture -	Picture minimum
colour up	colour maximum
colour down	colour minimum
brightness - bright	brightness maximum
brightness - dark	brightness minimum
hue - purplish	hue - purplish
hue - greenish	hue - greenish
sharpness - sharp	sharpness maximum
sharpness - soft	sharpness minimum
balance left	balance full left
balance right	balance full right
treble up	treble maximum
treble down	treble minimum
bass up	bass maximum
bass down	bass minimum

4-3. TEST MODE 2:

Test Mode 2 is available by pressing the 'TEST' button twice, OSD 'TT' appears. The functions described below are available by selecting the two numbers. To release the 'Test mode 2', press 00, 10, 20 ... twice or switch the TV set into Stand-by mode. In 'TT Menu' mode, it is possible to remove the Menu from the screen by pressing the Speaker Off button once. Pressing the Speaker OFF button a second time will cause the Menu to reappear. The function is kept even when the menu is not displayed on screen !!.

00	'TT' mode off
01	Picture maximum
02	Picture minimum
03	Set speaker/headphone Volume to 35%
04	Set speaker/headphone Volume to 50%
05	Set speaker/headphone Volume to 65%
06	Set speaker/headphone Volume to 80%
07	Ageing mode
08	Shipping Condition
11	Sub picture adjustment
12	Sub colour adjustment
13	Sub Brightness adjustment
14	Text H Position adjustment
15	Rotation Coil Test
16	Picture level 50%
19	Factory Mode Enable/Disable
21	Destination ADEKR
22	Destination BL
23	Destination ADEKR
24	Destination U
25	Destination ADEKR
26	Destination BL

27	Destination ADEKR
28	Destination ADEKR
31	Auto Shutoff Enable/Disable
33	Rotation ON/OFF
35	CRT 4:3 <-> 16:9 ; Display TV status
36	Velocity Modulation (VM) OFF/ON test
38	G2 adjustment
41	Re-initialise NVM
43	Select Dual A sound
44	Select Dual B sound
45	Select Mono sound
46	Select Stereo sound
48	Set NVM as non virgin
49	Set NVM as virgin
51	Virtual Dolby on/off
52	Subwoofer / MPB (Bass enhancement) Enable
54	Dot structure C/M (chroma trap)ination ADEKR
55	Tuner selection (SONY/ALPS)
56	BBE enable/disable
57	BBE menu line enable/disable
61	Auto AGC Adjustment
62	AM from baseband enable/disable
63	Enable/Disable YC3 connector
64	Enable/Disable RGB priority
65	RGB auto-detect enable/disable
66	On timer enable/disable
67	Manual AGC Adjustment
68	Enable/Disable X26 countermeasure (N problem)
69	Enable/Disable ACI feature
71	Force PAL video
72	Un-force PAL (restore normal video condition)
73	Enable Zweiton D/K2 system (6.5/6.74)
74	Enable Zweiton D/K3 system (6.5/5.74)
78	Balance full left
79	Balance full right
87	Local keys test
89	Enable/Disable watchdog
91	Set 14:9 zoom mode
92	Set SMART zoom mode
93	Set 16:9 zoom mode
94	Set ZOOM mode
95	Set 4:3 zoom mode
99	Display Error and Working Time menu

5-1. BLOCK DIAGRAMS (1)

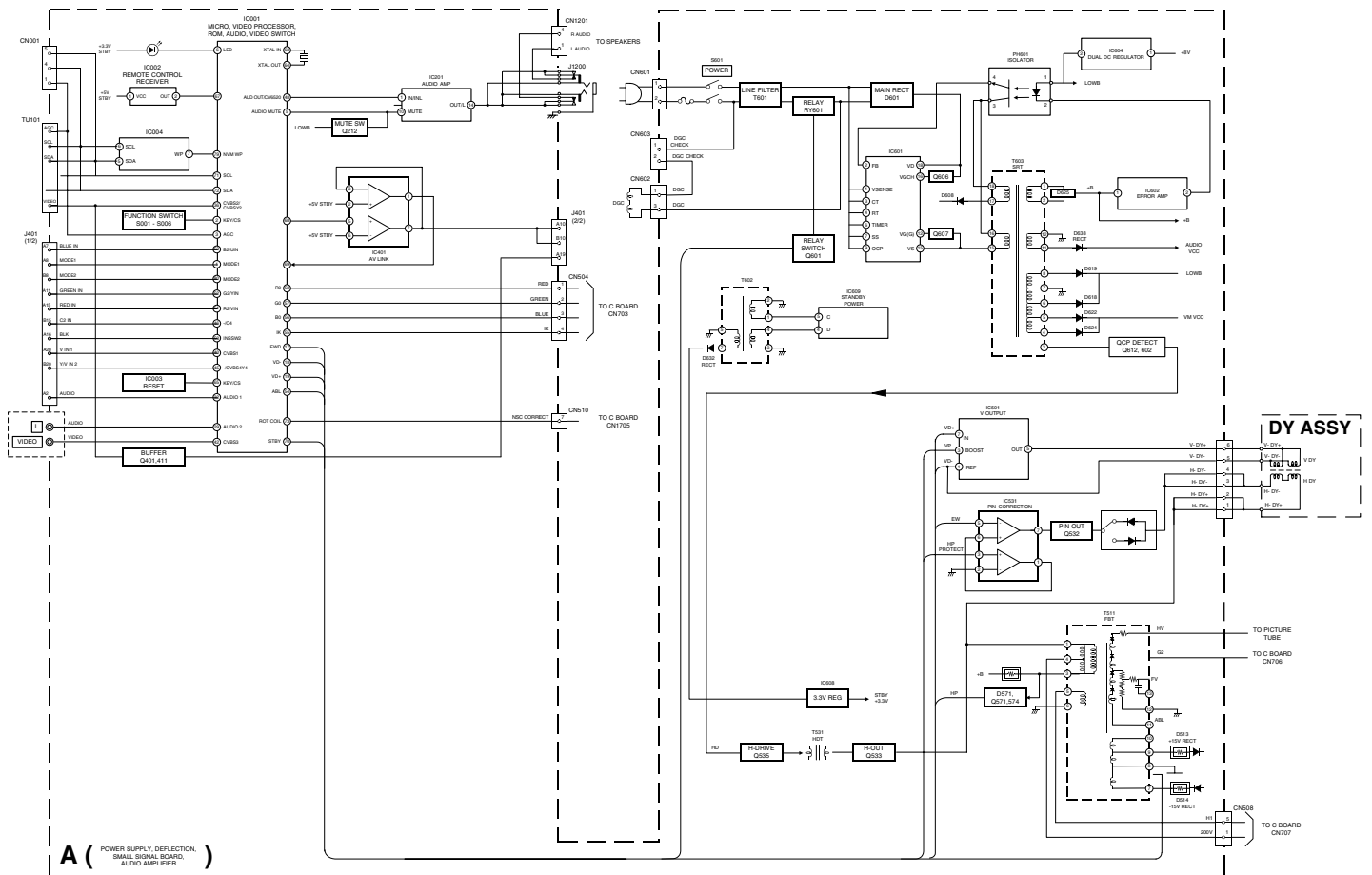

5-1. BLOCK DIAGRAMS (2)

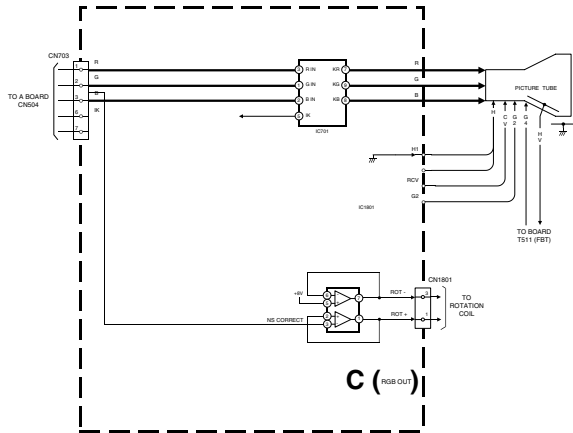

25

5-2. CIRCUIT BOARD LOCATION

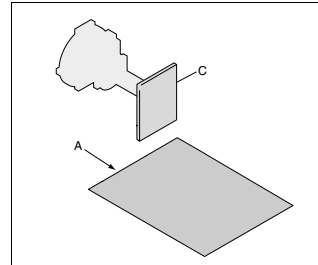

5-3. SCHEMATIC DIAGRAMS AND PRINTED WIRING BOARDS

Note :

- All capacitors are in μF unless otherwise noted.
- pF : μF 50WV or less are not indicated except for electrolytic types.
- Indication of resistance, which does not have one for rating electrical power, is as follows.

Pitch : 5mm
Electrical power rating : 1/4W

- Chip resistors are 1/10W
- All resistors are in ohms.
 $k = 1000$ ohms, $M = 1000,000$ ohms
- : nonflammable resistor.
- : fusible resistor.
- : internal component.
- : panel designation or adjustment for repair.
- All variable and adjustable resistors have characteristic curve B, unless otherwise noted.
- All voltages are in Volts.
- Readings are taken with a 10Mohm digital multimeter.
- Readings are taken with a color bar input signal.
- Voltage variations may be noted due to normal production tolerances.
- : B + bus.
- : B - bus.
- : RF signal path.
- : earth - ground.
- : earth - chassis.

Reference Information

RESISTOR	RN	METAL FILM
	RC	SOLID
	FPRD	NON FLAMMABLE CARBON
	FUSE	NON FLAMMABLE FUSIBLE
	RS	NON FLAMMABLE METAL OXIDE
	RB	NON FLAMMABLE CEMENT
	RW	NON FLAMMABLE WIREWOUND
		ADJUSTMENT RESISTOR
COIL	LF-SL	MICRO INDUCTOR
CAPACITOR	TA	TANTALUM
	PS	STYROL
	PP	POLYPROPYLENE
	PT	MYLAR
	MPS	METALIZED POLYESTER
	MPP	METALIZED POLYPROPYLENE
	ALB	BIPOLAR
	ALT	HIGH TEMPERATURE
	ALR	HIGH RIPPLE

Note : The components identified by shading and marked Δ are critical for safety. Replace only with the part numbers specified in the parts list.

Note : Les composants identifiés par une trame et par une marque Δ sont d'une importance critique pour la sécurité. Ne les remplacer que par des pièces de numéro spécifié.

26

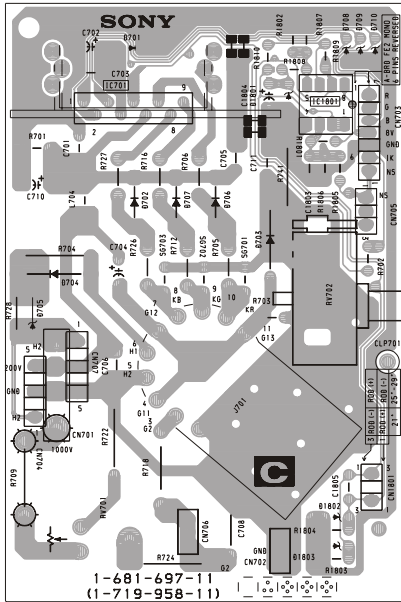

C Board Waveforms

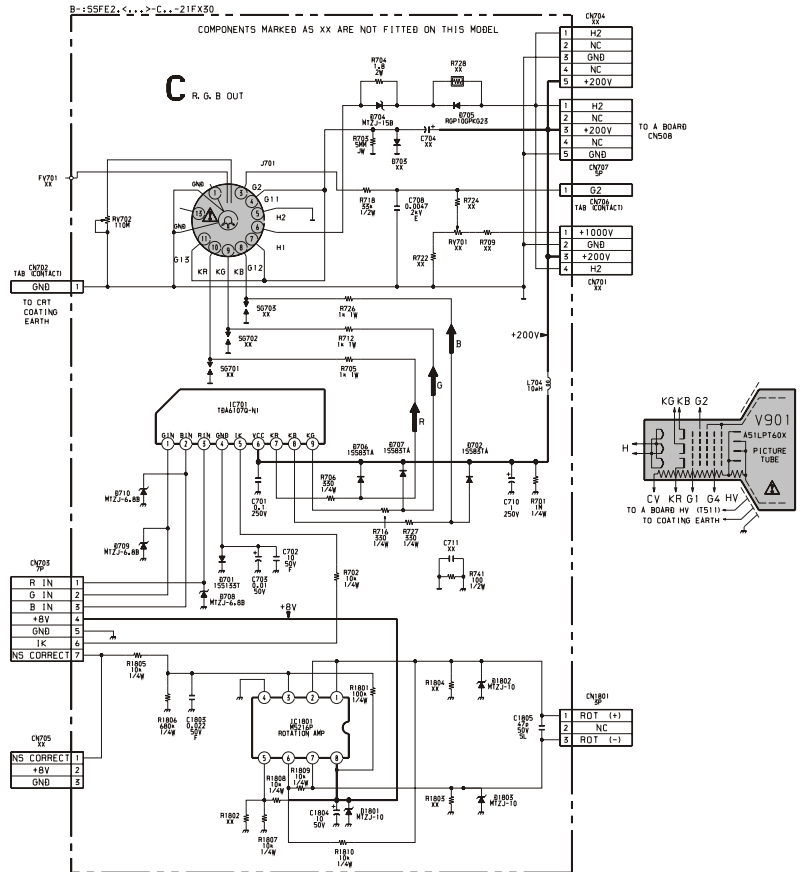
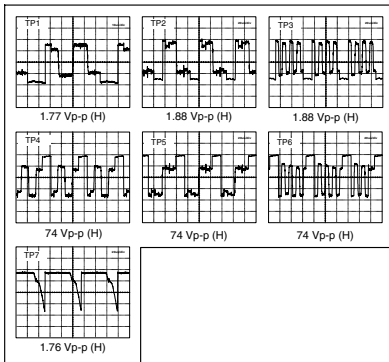

Semiconductor Voltage Table

Ref	(e)	(b)	(c)	Ref	(e)	(b)	(c)
Q701	124.2	124.8	202	Q706	7.5	8.1	125.0
Q702	2.3	3.0	7.5	Q707	124.6	125.6	5.5
Q703	7.5	8.1	131.6	Q708	3.5	2.1	7.5
Q704	131	132.4	5.2	Q709	7.5	8.1	123.3
Q705	2.5	3.1	7.5	Q710	123.0	124.3	5.5
				Q711	124.2	123.4	8.1

IC Voltage Table

Ref No	Pin No	Voltage (V)
IC1801	1	1.3
	2	1.3
	3	1.4
	5	4.1
	6	4.1
	7	7.0
	8	8.0

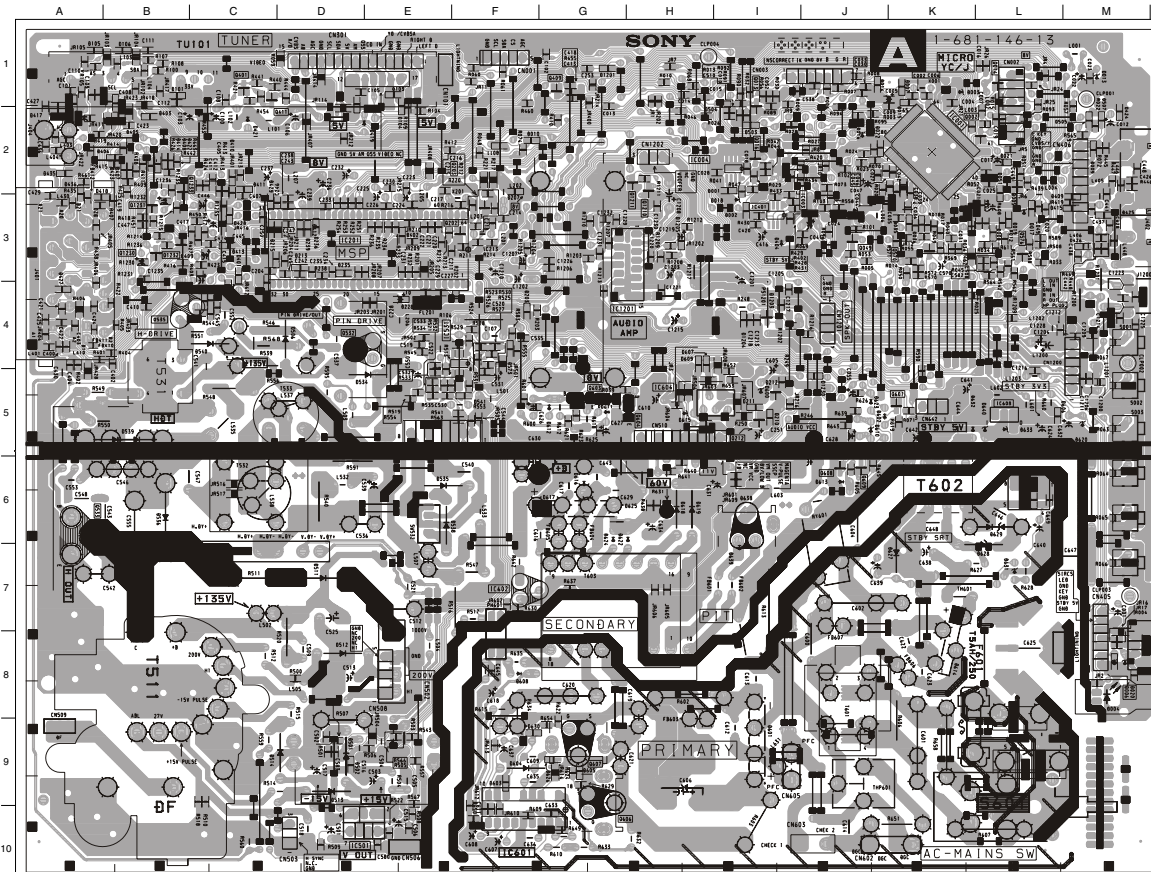

IC Voltage Table

Ref No	Pin No	Voltage (V)	Ref No	Pin No	Voltage (V)
IC001	1	0	IC001	67	4.8
	2	3.2		68	0.4
	3	2.9		69	0
	5	0		70	0
	6	2.0		71	0
	8	2.3		72	0
	9	8.0		73	7.1
	10	5.0		74	5.0
	12	0		75	8.1
	13	0		76	-3.5
	14	4.0		77	0
	16	1.4		78	3.2
	17	1.5		79	3.2
	18	0		80	0
IC001	19	0	1	0.3	
	20	3.8	3	-12.6	
	21	3.8	5	0.2	
	22	5.0	6	13.9	
	26	0	7	0.3	
	28	3.5	1	1.4	
IC001	29	3.6	2	2.3	
	30	1.9	3	1.8	
	31	0.3	5	2.4	
	32	3.6	6	1.6	
	34	1.9	7	6.4	
	35	1.4	1	-80.4	
IC001	36	3.9	2	-80.5	
	38	1.9	3	-80.2	
	40	3.3	4	-80.2	
	42	3.3	5	-81.5	
	43	1.4	6	-81.6	
	45	0	7	-77.8	
	46	0	9	-81.8	
	47	3.6	10	-76	
	48	2.8	11	-81.9	
	49	2.3	12	-79.4	
	50	0.2	14	16.5	
	51	2.5	15	11	
	52	2.5	16	14.4	
	53	2.5	18	86.4	
54	2.1	1	11		
IC1201	55	5.2	3	4.9	
	56	3.0	5	0	
	57	3.1	6	0	
	58	3.1	7	11.3	
	59	3.2	9	0.3	
	62	0	10	0	
	63	0	12	0	
	64	0	14	11.35	
	65	0			

Semiconductor Voltage Table

Ref	(e)	(b)	(c)	Ref	(e)	(b)	(c)
Q013	0	0.7	0	Q604	0	0	2.5
Q016	0	0	3.3	Q608	0	0	5.6
Q012	0	0.7	0	Q609	5.6	5.6	0
Q021	4.8	4.2	1.8				
Q411	1.1	1.7	4.2	Ref	(a)	(g)	(d)
Q601	5.6	4.8	5.3	Q606	10.9	14.5	86.7
Q602	14.2	5.1	8	Q607	-82.4	-79.9	10.9
Q603	8	8	0	Q635	0	2.5	95.2

Semiconductor Location Table

DIODE	D419	E-2	D022	J-2	D207	F-3	D405	B-2	D419	E-2	D436	A-2	D614	C-9	D602	J-5	D619	H-6	D632	K-5	Q013	I-3	Q533	A-6	Q1210	H-3	IC201	D-3	
D001	I-2	D011	F-2	D035	K-3	D210	I-5	D406	B-2	D420	B-2	D501	D-9	D534	E-5	D604	F-9	D620	M-5	D633	L-5	Q014	L-1	Q535	B-4	Q1211	H-3	IC201	I-3
D002	I-3	D012	J-3	D036	K-3	D211	I-5	D407	B-2	D421	C-2	D502	D-9	D535	E-6	D608	F-8	D621	J-5	D638	L-6	Q049	J-3	Q601	K-5	Q1230	B-3	IC501	E-10
D003	K-2	D013	M-1	D051	L-3	D212	I-5	D408	B-2	D422	C-2	D503	I-2	D536	B-6	D610	J-5	D623	J-5	D640	L-5	Q202	E-3	Q602	G-5	Q1231	B-3	IC501	F-4
D004	M-4	D014	J-1	D101	B-1	D229	E-4	D410	C-2	D423	C-2	D504	I-2	D537	C-4	D611	G-5	D624	G-6	D649	L-6	Q203	F-2	Q603	G-5	Q1232	B-3	IC501	F-10
D005	L-3	D016	J-2	D103	E-1	D236	D-3	D411	C-3	D424	M-2	D505	M-2	D538	E-6	D612	G-5	D625	H-6	D1204	I-4	Q212	I-5	Q604	H-5	Q1233	C-2	IC602	F-7
D022	J-2	D018	I-3	D104	E-2	D239	D-3	D412	D-3	D427	A-4	D506	D-4	D539	B-5	D613	J-6	D627	K-7	D1205	I-4	Q401	C-1	Q606	G-10	IC606	G-10	IC501	H-5
D027	F-3	D019	L-3	D105	A-1	D402	E-3	D413	C-3	D428	C-3	D507	M-2	D641	F-5	D614	K-8	D628	L-7	D1230	D-5	Q409	G-1	Q607	G-9	IC001	K-2	IC608	L-5
D405	B-2	D020	M-8	D106	B-1	D403	B-2	D414	B-2	D429	D-3	D512	D-8	D573	F-5	D615	H-5	D629	L-7	Q411	D-2	Q608	J-6	IC002	M-8	IC009	L-6	IC501	L-6
D406	L-3	D021	L-2	D107	B-2	D404	I-3	D418	B-3	D435	A-2	D513	D-9	D601	I-9	D618	H-6	D631	L-7	Q002	K-2	Q532	D-4	Q609	J-6	IC004	H-2	IC201	H-4

NOTE:
Portions of the circuit marked as shown are high voltage areas. Use care to prevent electric shock during inspection or repair.

A [PRINTED WIRING BOARD]

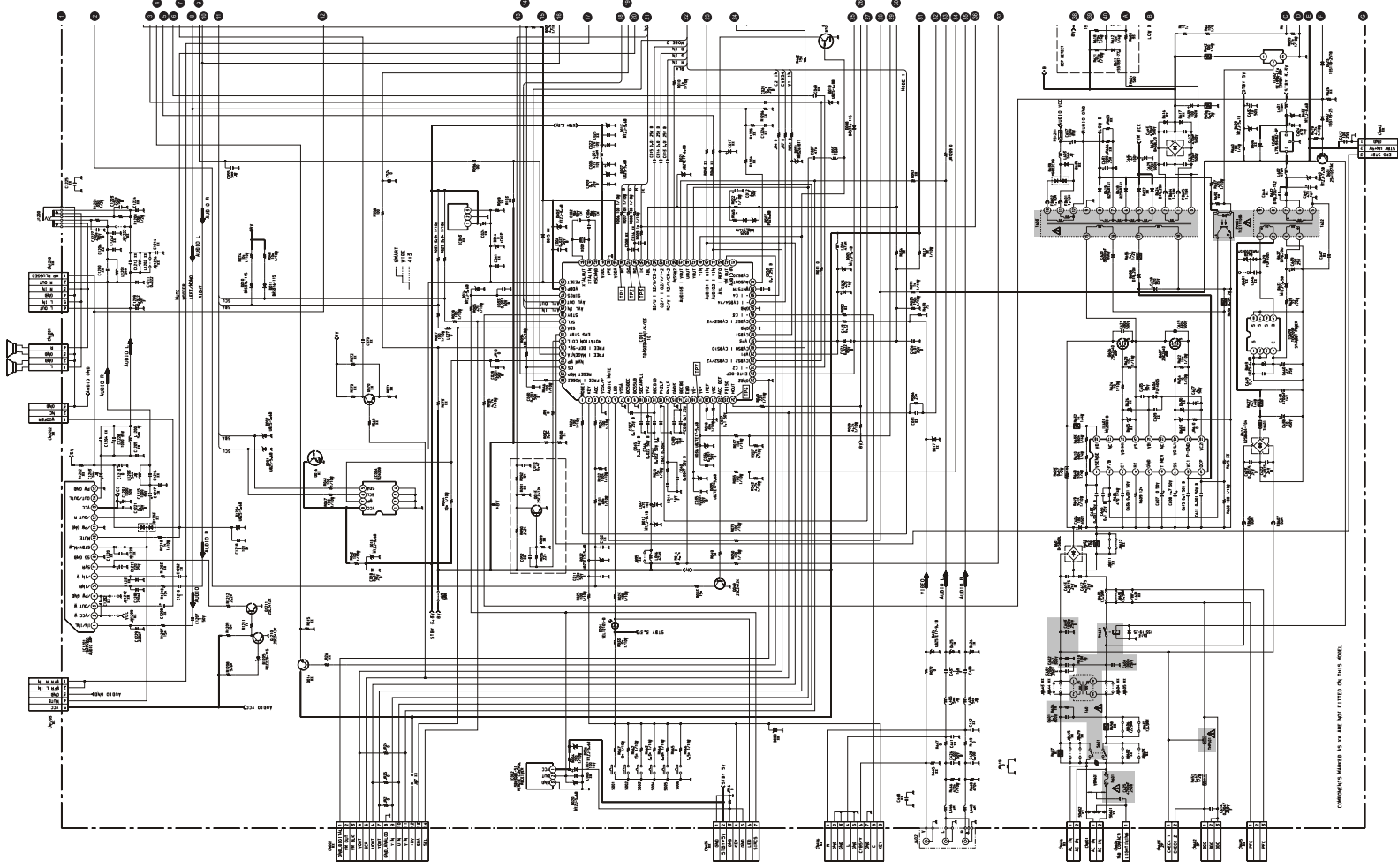

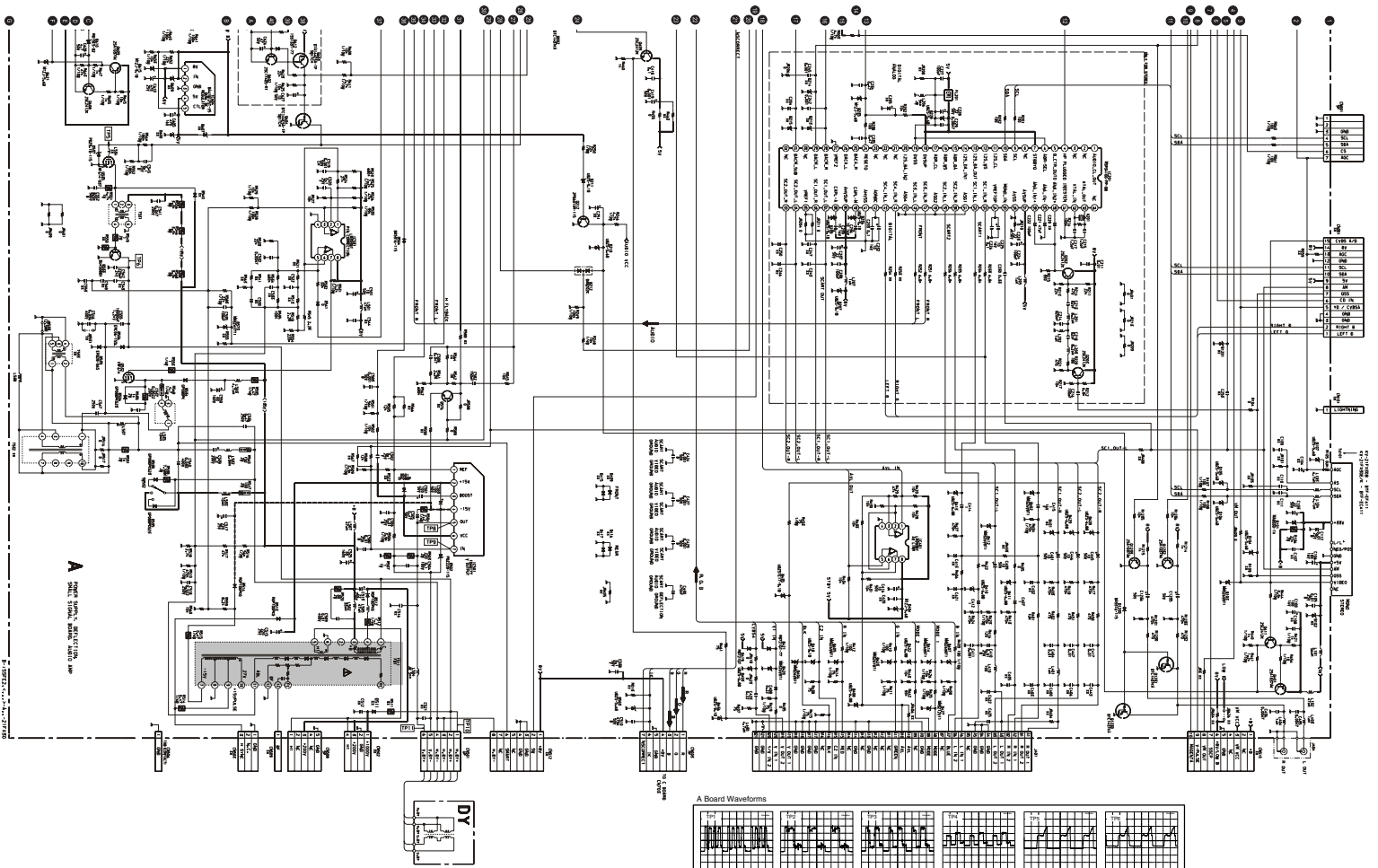

A [POWER SUPPLY, DEFLECTION, AUDIO AMPLIFIER (Page 22)]

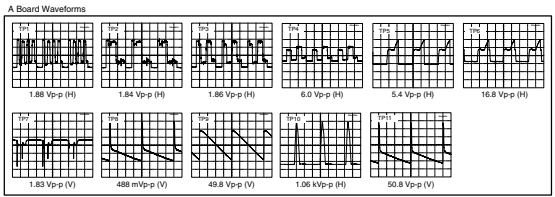

5-4. SEMICONDUCTORS

LM358N
LM393DT
LM393N
M5216P
TDA2822M
TEA2124

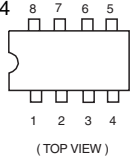

TDA9394H

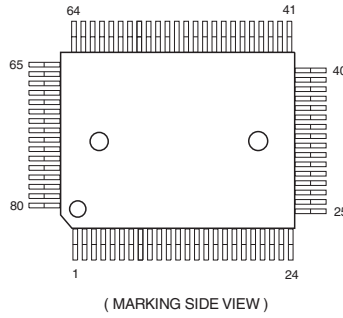

IRF614-005
IRF614-037
IRF620



MSP3410D-PP-B8

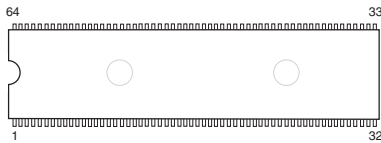

TOP209P

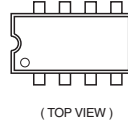

2SA933AS-QRT
2SAG33ASQT
2SA933AS-RT
2SC1740S-RT

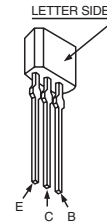

SE-135N
SE135N-LF4

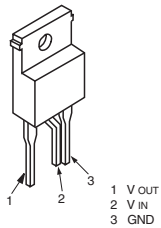

BF421-AMMO
2SA1091-O



2SC2785-HFE

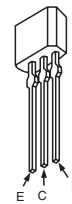

STV9379

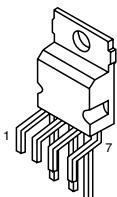

DTA144ESA
DTA144ESA-TP
DTC114EKA-T146
DTC143TKA-T146
DTC144EKA-T-146R
2SA1037K-T-146-R
R2SA1162-G
2SA1037AK-T-146-QR
2SD601A-QTX
2SC1623-L5-L6
2SC2412K-QR
2SC2412K-T-146-QR
2SC2412K-T-146-R

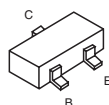

2SK2251-01-F19

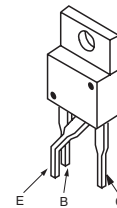

AK04-V1
 AU-01Z-V1
 BYD33G
 BYD33G-AMMO
 DINL20-TA
 DINL20-U-TA2
 DINL40-U-TR2
 ERB44-06TP1
 EGP20G
 EG-1Z-V1
 EL1Z
 ERD28-06S

ERD28-06S
 ERC06-15SL
 FMN-G12S
 GP08DPKG23
 RGP10GPKG23
 RG15GPKG23
 RG1CLF-B1
 RU-3AM
 RU3YX-LF-C4
 RU3YX-V1
 RU-4AM-T3
 1SS292T-77

ERA81-004TP1
 ERA83-006
 MTZJ-3.6A
 MTZJ-T-77-2.2A
 HZS9.INBZ
 MTZJ-T-77-3.6B
 MTZJ-T-77-4.7B
 MTZJ-T-77-5.1B
 MTZJ-T-77-5.6B
 MTZJ-T-77-6.8A
 MTZJ-T-77-8.2B
 MTZJ-T-77-7.5B
 MTZJ-T-77-9.1
 MTZJ-T-77-9.1B
 MTZJ-T-77-10

MTZJ-T-72-10A
 MTZJ-T-72-10B
 MTZJ-T-77-15B
 MTZJ-T-77-33A
 MTZJ-33C
 MTZJ-7.5B
 P6KE200ASY
 RD3.9ES-B2
 RD7.5ESB2
 RD9.1ES-B3
 RD10ESB2
 RD15ES-T1B2
 1SS119-25TD
 1SS133T-77

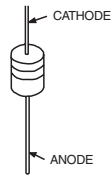
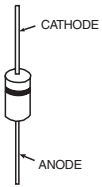

SLA-570KT3F

DAN202K
 DAN202K-T146
 MA8330-TX

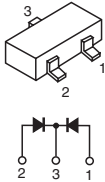
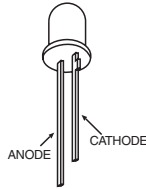

1SS355TE-17
 RD12SB2
 UDZS-TE-17-4.7B
 UDZS-TE-17-5.6B
 UDZS-TE-17-6.8B
 UDZS-TE-17-9.1B
 UDZ-TE-17-22B

D4SB60L-F

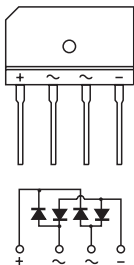
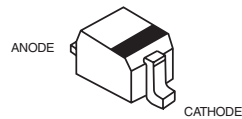

UF4005PKG23

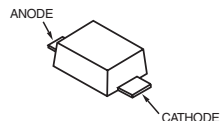

5-5 IC BLOCK DIAGRAMS

A BOARD IC604 BA41W12ST-V5

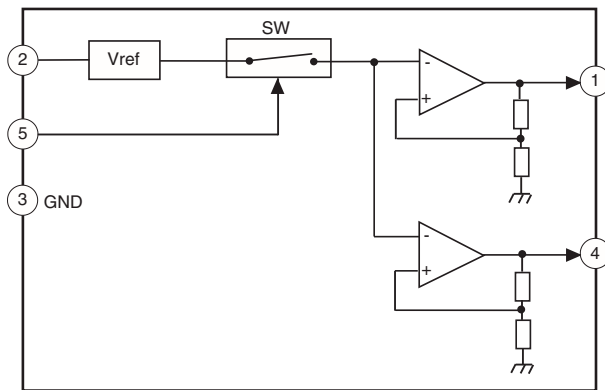

A BOARD IC401/IC531 LM393DT

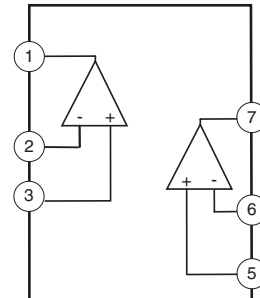

A BOARD IC601 MCZ3001D

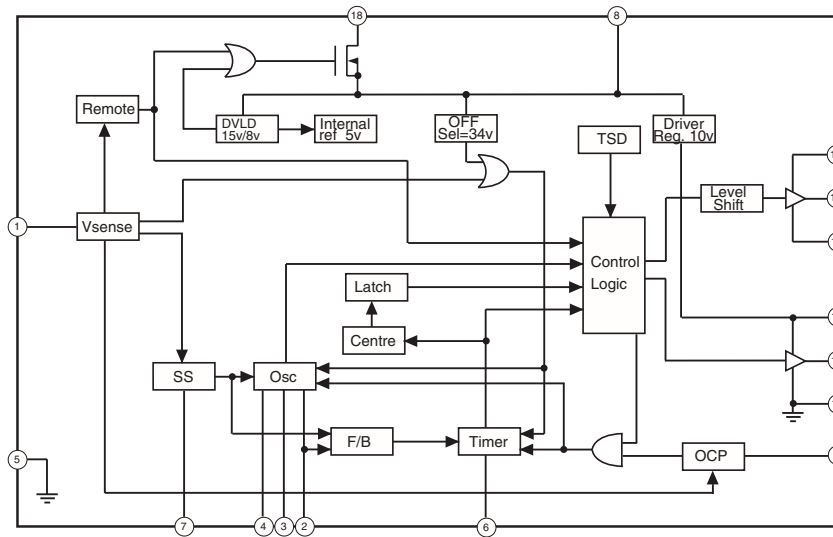

A BOARD IC1201 TDA7497

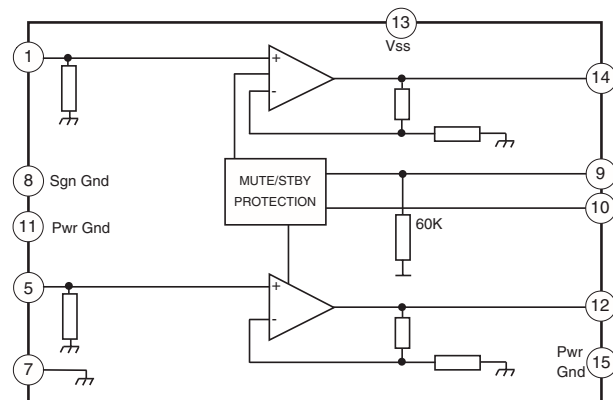

SECTION 6 EXPLODED VIEWS

NOTE :

- Items with no part number and no description are not stocked because they are seldom required for routine service.
- The construction parts of an assembled part are indicated with a collation number in the remarks column.
- Items marked “*” are not stocked since they are seldom required for routine service. Some delay should be anticipated when ordering these items.

6-1. CHASSIS

Note : Les composants identifiés par une trame et par une marque Δ sont d'une importance critique pour la sécurité. Ne les remplacer que par des pièces du numéro spécifié.

Note : The components identified by shading and marked Δ are critical for safety. Replace only with the part numbers specified in the parts list.

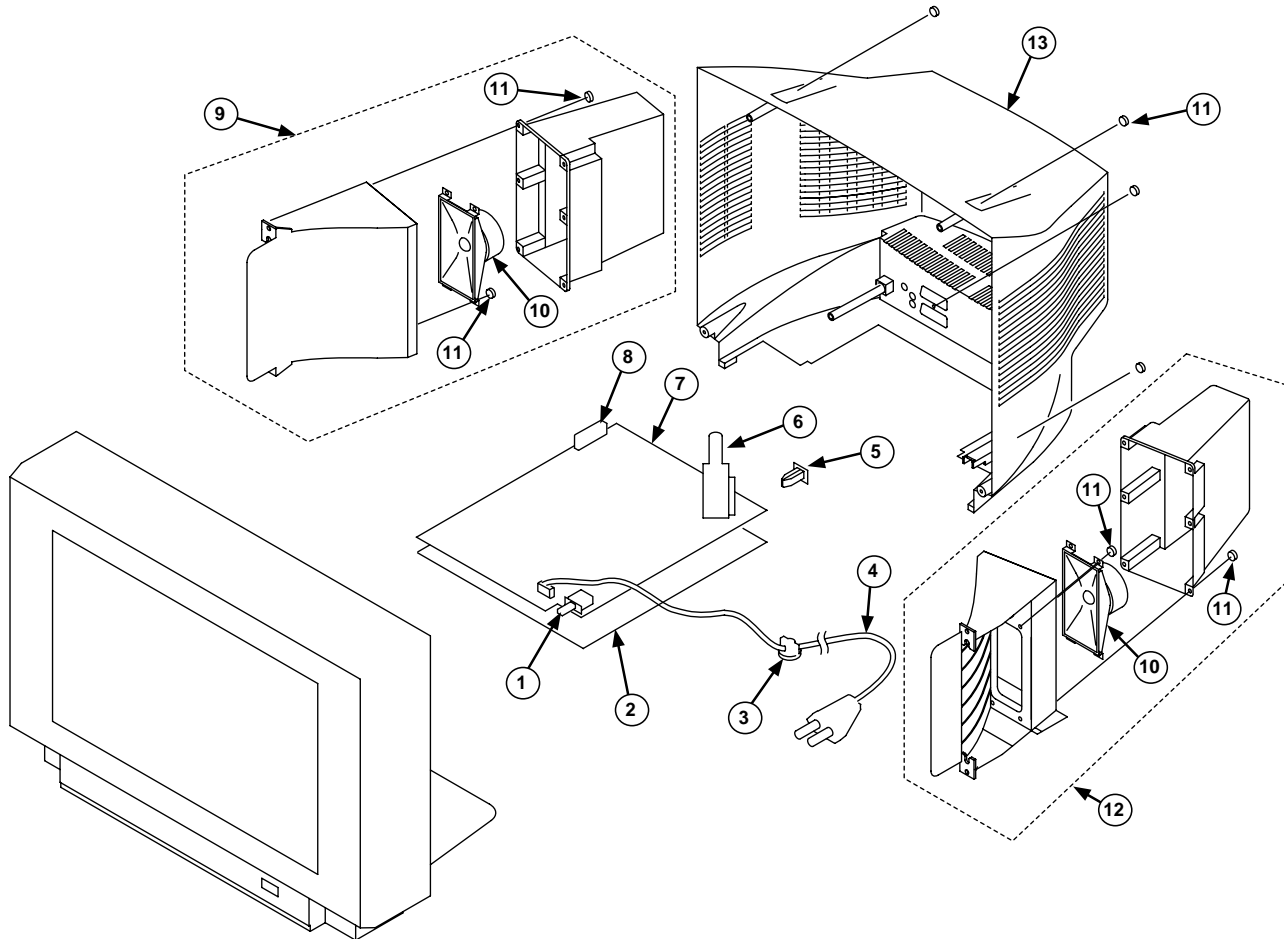

REF.NO.	PART.NO	DESCRIPTION	REMARK	REF.NO.	PART.NO	DESCRIPTION	REMARK
1	Δ 1-571-433-31	SWITCH, PUSH (AC POWER)		8	8-598-535-10	FRONTEND (BTF-EF411) (KV-21FX30B)	
2	*4-204-143-04	BRACKET, MAIN			8-598-533-00	FRONTEND (BTF-EC411) (KV-21FX30E/21FX30K)	
3	*4-202-531-01	AC CORD LOCK (SC)		9	A-1678-206-A	SPEAKER BOX ASSY LEFT	10,11
4	Δ 1-765-286-11	CORD POWER		10	1-505-924-11	SPEAKER (15X6.5CM)	
5	*4-204-517-05	SUPPORT, FBT		11	4-039-358-01	SCREW, (4x16) (+) BV TAPPING	
6	Δ 1-453-314-31	TRANSFORMER ASSY, FLYBACK		12	A-1678-207-A	SPEAKER BOX ASSY RIGHT	10,11
7	*A-1632-936-A	A BOARD, COMPLETE (KV-21FX30B)		13	4-204-711-11	COVER, REAR	
	*A-1632-930-A	A BOARD, COMPLETE (KV-21FX30E/21FX30K)					

6-2. PICTURE TUBE

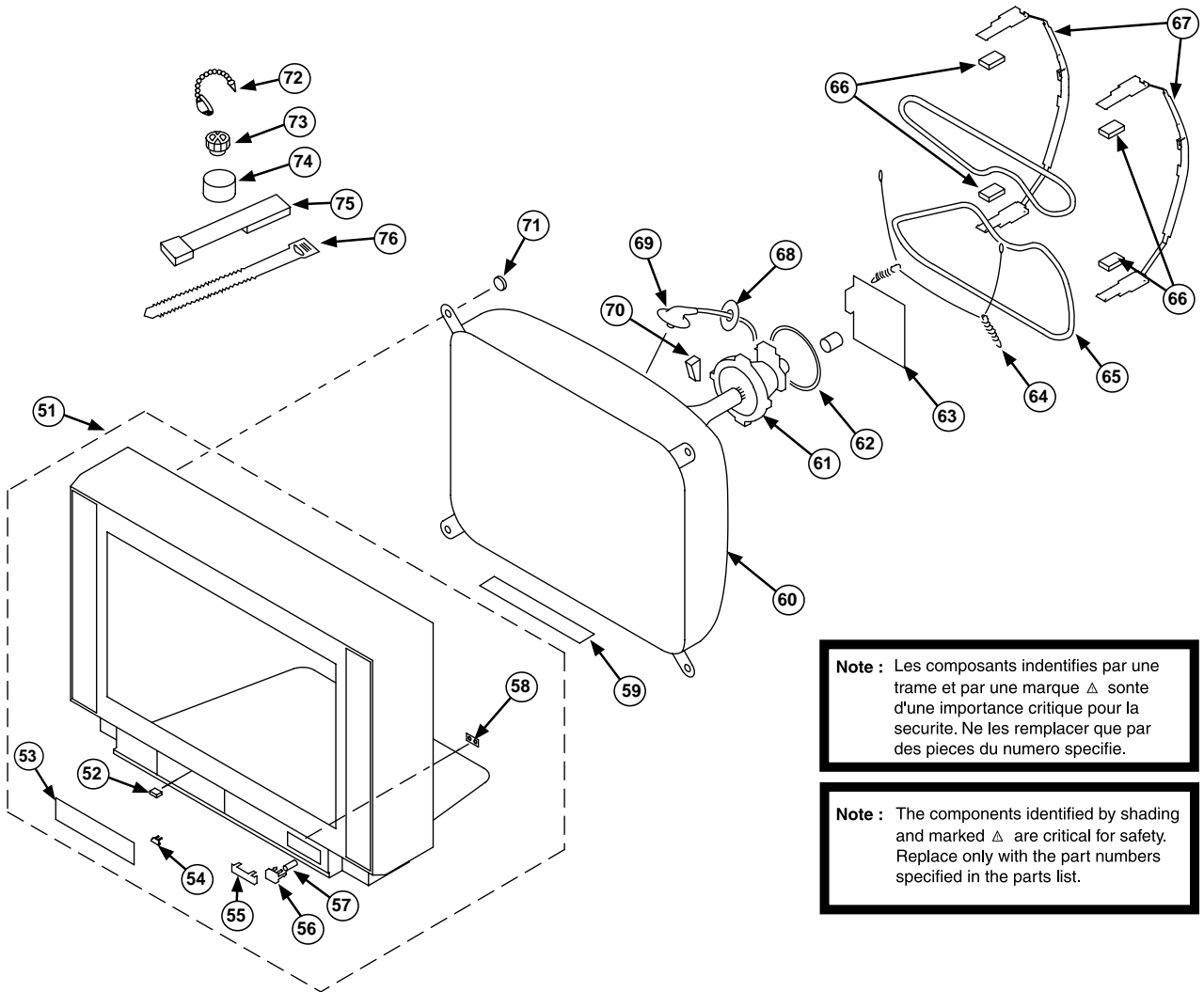

Note : Les composants identifiés par une trame et par une marque Δ sont d'une importance critique pour la sécurité. Ne les remplacer que par des pièces du numéro spécifié.

Note : The components identified by shading and marked Δ are critical for safety. Replace only with the part numbers specified in the parts list.

REF.NO.	PART.NO	DESCRIPTION	REMARK	REF.NO.	PART.NO	DESCRIPTION	REMARK
51	X-4200-723-1	BEZNET ASSY	52-58	64	4-369-318-22	SPRING, TENSION	
52	4-047-464-01	CATCHER, PUSH		65	Δ 1-419-772-11	COIL, DEGAUSSING	
53	4-204-901-21	DOOR, (PAINTED)		66	*4-205-248-01	CUSHION DGC	
54	3-703-035-12	SHAFT LID		67	4-204-900-01	BAND, DGC	
55	4-204-902-11	WINDOW, ORNAMENTAL (PRINTED)		68	*4-203-022-01	HOLDER, HV	
56	4-204-903-11	BUTTON, POWER (PAINTED)		69	Δ 1-251-839-21	CAP ASSY, HIGH VOLTAGE	
57	4-204-426-01	SPRING		70	4-203-658-01	SPACER, DY	
58	4-204-706-01	GUIDE, LIGHT		71	4-203-648-01	SCREW (5), SELF-TAPPING	
59	4-204-666-01	SHEET, BLOTING		72	4-308-870-00	CLIP, LEAD WIRE	
60	Δ 8-738-836-05	PICTURE TUBE (A51LPT60X)		73	1-452-094-11	MAGNET, ROTABLE DISK; 15MM \emptyset	
61	8-451-505-41	DEFLECTION YOKE (Y21RSA-L)		74	1-452-032-11	MAGNET, DISK; 10MM \emptyset	
62	1-452-728-61	COIL, NA ROTATION (RT-154)		75	X-4387-214-1	PERMALLOY ASSY, CORRECTION	
63	*A-1639-020-A	C BOARD, COMPLETE		76	3-701-007-00	BAND, BINDING	

SECTION 7 ELECTRICAL PARTS LIST

PARTS LISTING TABLE OF CONTENTS

	<u>Page</u>
A BOARD COMMON Parts List : Parts common to all models listed in this manual	43
A BOARD VARIANT Parts List : Parts that belong only to the model specified	
Model	
KV-21FX30	50
C BOARD COMPLETE Parts List :	50
MISCELLANEOUS :	52
ACCESSORIES AND PACKAGING MATERIALS :	52

Note : Refer to the designated variant parts list when seeking a part indicated by an asterisk (*)
Parts indicated (XX) on the Schematic Diagram are not used in this model and therefore do not appear in the Parts List.

REF.NO.	PART.NO	DESCRIPTION	REMARK	REF.NO.	PART.NO	DESCRIPTION	REMARK
*A-1632-936-A A Board, Complete (KV-21FX30B)				C105	1-162-970-11	CERAMIC CHIP 0.01UF	10.00% 25V
*A-1632-930-A A Board, Complete (KV-21FX30E/ KV-21FX30K)				C106	1-126-933-91	ELECT 100UF	20.00% 16V
A Board, Common Parts				C112	1-162-970-11	CERAMIC CHIP 0.01UF	10.00% 25V
	4-203-258-02	HOLDER, LED		C211	1-162-970-91	CERAMIC CHIP 0.01UF	10.00% 25V
	*4-374-846-01	COVER, CAPACITOR, CAP TYPE		C213	1-163-249-91	CERAMIC CHIP 82PF	5.00% 50V
	4-382-854-01	SCREW (M3X8), P, SW (+)		C214	1-163-139-91	CERAMIC CHIP 820PF	5.00% 50V
	4-382-854-01	SCREW (M3X8), P, SW (+)		C215	1-163-084-91	CERAMIC CHIP 1.5PF	0.25PF 50V
		< CAPACITOR >		C216	1-163-117-91	CERAMIC CHIP 100PF	5.00% 50V
C001	1-126-933-91	ELECT 100UF	20.00% 16V	C217	1-163-084-91	CERAMIC CHIP 1.5PF	0.25PF 50V
C002	1-163-233-91	CERAMIC CHIP 18PF	5.00% 50V	C218	1-163-249-91	CERAMIC CHIP 82PF	5.00% 50V
C004	1-163-037-91	CERAMIC CHIP 0.022UF	10.00% 50V	C221	1-163-109-91	CERAMIC CHIP 47PF	5.00% 50V
C005	1-126-935-91	ELECT 470UF	20.00% 10V	C222	1-163-117-91	CERAMIC CHIP 100PF	5.00% 50V
C006	1-163-233-91	CERAMIC CHIP 18PF	5.00% 50V	C223	1-126-965-91	ELECT 22UF	20.00% 50V
C007	1-162-949-91	CERAMIC CHIP 47PF	5.00% 50V	C224	1-163-117-91	CERAMIC CHIP 100PF	5.00% 50V
C009	1-164-004-91	CERAMIC CHIP 0.1UF	10.00% 25V	C225	1-126-157-91	ELECT 10UF	20.00% 16V
C010	1-164-005-91	CERAMIC CHIP 0.47UF	16V	C226	1-164-004-91	CERAMIC CHIP 0.1UF	10.00% 25V
C011	1-163-005-91	CERAMIC CHIP 470PF	10.00% 50V	C227	1-163-117-91	CERAMIC CHIP 100PF	5.00% 50V
C012	1-126-963-91	ELECT 4.7UF	20.00% 50V	C228	1-126-965-91	ELECT 22UF	20.00% 50V
C013	1-162-970-11	CERAMIC CHIP 0.01UF	10.00% 25V	C229	1-163-017-91	CERAMIC CHIP 0.0047UF	10.00% 50V
C014	1-162-970-11	CERAMIC CHIP 0.01UF	10.00% 25V	C230	1-164-336-91	CERAMIC CHIP 0.33UF	25V
C015	1-162-970-11	CERAMIC CHIP 0.01UF	10.00% 25V	C232	1-126-157-91	ELECT 10UF	20.00% 16V
C018	1-162-970-11	CERAMIC CHIP 0.01UF	10.00% 25V	C233	1-164-004-91	CERAMIC CHIP 0.1UF	10.00% 25V
C020	1-164-004-91	CERAMIC CHIP 0.1UF	10.00% 25V	C234	1-107-823-91	CERAMIC CHIP 0.47UF	10.00% 16V
C021	1-163-037-91	CERAMIC CHIP 0.022UF	10.00% 50V	C235	1-164-005-91	CERAMIC CHIP 0.47UF	25V
C022	1-126-935-91	ELECT 470UF	20.00% 10V	C236	1-126-157-91	ELECT 10UF	20.00% 16V
C025	1-126-935-91	ELECT 470UF	20.00% 16V	C237	1-126-965-91	ELECT 22UF	20.00% 50V
C026	1-162-970-11	CERAMIC CHIP 0.01UF	10.00% 25V	C238	1-163-117-91	CERAMIC CHIP 100PF	5.00% 50V
C027	1-164-004-91	CERAMIC CHIP 0.1UF	10.00% 25V	C239	1-126-157-91	ELECT 10UF	20.00% 16V
C028	1-163-009-91	CERAMIC CHIP 0.001UF	10.00% 50V	C242	1-163-009-91	CERAMIC CHIP 0.001UF	10.00% 50V
C030	1-163-009-91	CERAMIC CHIP 0.001UF	10.00% 50V	C245	1-163-009-91	CERAMIC CHIP 0.001UF	10.00% 50V
C033	1-163-009-91	CERAMIC CHIP 0.001UF	10.00% 50V	C401	1-126-964-91	ELECT 10UF	20.00% 50V
C035	1-163-009-91	CERAMIC CHIP 0.001UF	10.00% 50V	C404	1-162-970-91	CERAMIC CHIP 0.01UF	10.00% 25V
C036	1-163-009-91	CERAMIC CHIP 0.001UF	10.00% 50V	C407	1-164-346-91	CERAMIC CHIP 1UF	16V
C037	1-136-244-11	FILM 0.1UF	2.00% 50V	C408	1-127-715-91	CERAMIC CHIP 0.22UF	10% 16V
C038	1-163-038-91	CERAMIC CHIP 0.1UF	25V	C409	1-126-964-91	ELECT 10UF	20.00% 50V
C039	1-164-505-91	CERAMIC CHIP 2.2UF	16V	C410	1-162-970-11	CERAMIC CHIP 0.01UF	10.00% 25V
C040	1-163-017-91	CERAMIC CHIP 0.0047UF	10.00% 50V	C411	1-163-009-91	CERAMIC CHIP 0.001UF	10.00% 50V
C042	1-163-017-91	CERAMIC CHIP 0.0047UF	10.00% 50V	C412	1-164-346-91	CERAMIC CHIP 1UF	16V
C043	1-163-037-91	CERAMIC CHIP 0.022UF	10.00% 50V	C414	1-164-346-91	CERAMIC CHIP 1UF	16V
C044	1-164-346-91	CERAMIC CHIP 1UF	16V	C415	1-164-346-91	CERAMIC CHIP 1UF	16V
C045	1-164-489-91	CERAMIC CHIP 0.22UF	10.00% 16V	C416	1-126-964-91	ELECT 10UF	20.00% 50V
C046	1-163-037-91	CERAMIC CHIP 0.022UF	10.00% 50V	C417	1-162-970-11	CERAMIC CHIP 0.01UF	10.00% 25V
C047	1-126-935-91	ELECT 470UF	20.00% 16V	C418	1-164-004-91	CERAMIC CHIP 0.1UF	10.00% 25V
C053	1-164-004-91	CERAMIC CHIP 0.1UF	10.00% 25V	C419	1-162-964-91	CERAMIC CHIP 0.001UF	10.00% 50V
C055	1-535-143-61	LEAD, JUMPER (5.0MM)		C423	1-127-715-91	CERAMIC CHIP 0.22UF	10% 16V
C100	1-126-933-91	ELECT 100UF	20.00% 16V	C424	1-163-009-91	CERAMIC CHIP 0.001UF	10.00% 50V
C103	1-126-965-91	ELECT 22UF	20.00% 50V	C426	1-163-009-91	CERAMIC CHIP 0.001UF	10.00% 50V
				C427	1-163-009-91	CERAMIC CHIP 0.001UF	10.00% 50V
				C428	1-163-009-91	CERAMIC CHIP 0.001UF	10.00% 50V
				C429	1-163-009-91	CERAMIC CHIP 0.001UF	10.00% 50V

A

Note : The components identified by shading and marked Δ are critical for safety. Replace only with the part numbers specified in the parts list.

REF.NO.	PART.NO	DESCRIPTION	REMARK	REF.NO.	PART.NO	DESCRIPTION	REMARK
C430	1-102-114-91	CERAMIC 470PF	10.00% 50V	C605	1-111-036-91	ELECT 470UF	20.00% 16V
C435	1-163-017-91	CERAMIC CHIP 0.0047UF	10.00% 50V	C606	1-125-991-11	ELECT 180UF	20% 450V
C436	1-163-017-91	CERAMIC CHIP 0.0047UF	10.00% 50V	C607	1-126-964-91	ELECT 10UF	20.00% 50V
C437	1-164-346-91	CERAMIC CHIP 1UF	16V	C608	1-126-963-91	ELECT 4.7UF	20.00% 50V
C438	1-164-346-91	CERAMIC CHIP 1UF	16V	C610	1-126-941-91	ELECT 470UF	20.00% 25V
C445	1-126-964-91	ELECT 10UF	20.00% 50V	C611	1-163-009-91	CERAMIC CHIP 0.001UF	10.00% 50V
C446	1-126-964-91	ELECT 10UF	20.00% 50V	C612	1-104-571-91	CERAMIC 0.0015UF	10.00% 2KV
C447	1-162-970-11	CERAMIC CHIP 0.01UF	10.00% 25V	C613	1-104-571-91	CERAMIC 0.0015UF	10.00% 2KV
C449	1-127-715-91	CERAMIC CHIP 0.22UF	10% 16V	C614	1-161-964-51	CERAMIC 0.0047UF	250V
C501	1-126-968-91	ELECT 100UF	20.00% 50V	C615	1-115-339-91	CERAMIC CHIP 0.1UF	10.00% 50V
C502	1-163-038-91	CERAMIC CHIP 0.1UF	25V	C616	1-165-127-91	CERAMIC 470PF	10.00% 500V
C503	1-126-968-91	ELECT 100UF	20.00% 50V	C617	1-165-127-91	CERAMIC 470PF	10.00% 500V
C504	1-106-220-91	MYLAR 0.1UF	10.00% 100V	C618	1-126-949-91	ELECT 220UF	20.00% 35V
C505	1-137-194-81	FILM 0.47UF	5.00% 50V	C619	1-164-644-51	CERAMIC 330PF	10.00% 500V
C506	1-162-970-11	CERAMIC CHIP 0.01UF	10.00% 25V	C620	1-137-990-21	FILM 33000PF	3% 800V
C508	1-163-035-91	CERAMIC CHIP 0.047UF	50V	C621	1-164-644-51	CERAMIC 330PF	10.00% 500V
C509	1-107-364-81	MYLAR 0.01UF	10.00% 400V	C622	1-104-571-91	CERAMIC 0.0015UF	10.00% 2KV
C510	1-163-005-91	CERAMIC CHIP 470PF	10.00% 50V	C623	1-104-571-91	CERAMIC 0.0015UF	10.00% 2KV
C513	1-107-662-91	ELECT 22UF	20.00% 250V	C624	1-126-935-91	ELECT 470UF	20.00% 16V
C515	1-104-666-91	ELECT 220UF	20.00% 25V	C625	Δ 1-127-798-51	CERAMIC 4700PF	20.00% 250V
C517	1-104-666-91	ELECT 220UF	20.00% 25V	C626	1-126-967-91	ELECT 47UF	20.00% 50V
C518	1-106-375-81	MYLAR 0.022UF	10.00% 250V	C627	1-126-964-91	ELECT 10UF	20.00% 50V
C519	1-163-275-91	CERAMIC CHIP 0.001UF	5.00% 50V	C628	1-126-963-91	ELECT 4.7UF	20.00% 50V
C520	1-163-038-91	CERAMIC CHIP 0.1UF	25V	C629	1-165-127-91	CERAMIC 470PF	10.00% 500V
C524	1-216-295-91	SHORT 0		C630	1-107-648-41	ELECT 100UF	20.00% 160V
C525	1-123-024-51	ELECT 33UF	160V	C631	1-126-942-91	ELECT 1000UF	20.00% 25V
C531	1-126-964-91	ELECT 10UF	20.00% 50V	C632	1-126-964-91	ELECT 10UF	20.00% 50V
C532	1-163-017-91	CERAMIC CHIP 0.0047UF	10.00% 50V	C633	1-163-009-91	CERAMIC CHIP 0.001UF	10.00% 50V
C535	1-163-251-91	CERAMIC CHIP 100PF	5.00% 50V	C634	1-128-562-91	ELECT 47UF	20.00% 100V
C536	1-137-713-11	FILM 0.47UF	5% 250V	C635	1-136-165-81	FILM 0.1UF	5.00% 50V
C537	1-106-351-91	MYLAR 0.0022UF	99% 200V	C636	1-136-479-41	FILM 0.001UF	2.00% 50V
C538	1-165-319-91	CERAMIC CHIP 0.1UF	50V	C637	1-126-967-91	ELECT 47UF	20.00% 50V
C539	1-107-642-91	ELECT 3.3UF	20.00% 200V	C638	1-107-679-91	ELECT 10UF	20.00% 450V
C540	1-137-051-91	FILM 0.033UF	10.00% 400V	C639	1-104-665-91	ELECT 100UF	20.00% 25V
C541	1-106-383-91	MYLAR 0.047UF	10.00% 200V	C640	1-104-664-91	ELECT 47UF	20.00% 25V
C542	1-162-131-91	CERAMIC 220PF	10.00% 2KV	C641	1-115-785-91	ELECT 470UF	20.00% 16V
C545	1-164-004-91	CERAMIC CHIP 0.1UF	10.00% 25V	C642	1-104-665-91	ELECT 100UF	20.00% 25V
C546	1-135-840-51	FILM 0.036UF	3% 400V	C643	1-165-127-91	CERAMIC 470PF	10.00% 500V
C547	1-115-522-21	FILM 1UF	5.00% 250V	C645	1-164-004-91	CERAMIC CHIP 0.1UF	10.00% 25V
C550	1-107-638-91	ELECT 33UF	20.00% 160V	C648	1-125-782-91	CERAMIC 4700PF	10.00% 1KV
C552	1-102-212-91	CERAMIC 820PF	10.00% 500V	C649	1-163-038-91	CERAMIC CHIP 0.1UF	25V
C555	1-117-644-31	FILM 10000PF	3.00% 1.2KV	C657	1-126-952-91	ELECT 1000UF	20.00% 35V
C580	1-162-970-11	CERAMIC CHIP 0.01UF	10.00% 25V	C1201	1-126-972-51	ELECT 1000UF	20.00% 50V
C582	1-163-255-91	CERAMIC CHIP 150PF	5.00% 50V	C1203	1-535-143-61	LEAD, JUMPER (5.0MM)	
C583	1-163-009-91	CERAMIC CHIP 0.001UF	10.00% 50V	C1207	1-126-960-91	ELECT 1UF	20.00% 50V
C600	1-119-888-51	CERAMIC 2200PF	20.00% 250V	C1209	1-163-033-91	CERAMIC CHIP 0.022UF	50V
C601	Δ 1-136-516-12	FILM 0.1UF	20.00% 300V	C1210	1-126-960-91	ELECT 1UF	20.00% 50V
C602	Δ 1-136-516-12	FILM 0.1UF	20.00% 300V	C1211	1-163-033-91	CERAMIC CHIP 0.022UF	50V
C603	Δ 1-119-899-51	CERAMIC 1000PF	20.00% 250V	C1213	1-216-295-91	SHORT 0	
C604	Δ 1-119-899-51	CERAMIC 1000PF	20.00% 250V	C1215	1-126-952-91	ELECT 1000UF	20.00% 35V

REF.NO.	PART.NO	DESCRIPTION	REMARK	REF.NO.	PART.NO	DESCRIPTION	REMARK
C1218	1-109-982-91	CERAMIC CHIP 1UF	10.00% 10V	D106	8-719-069-55	DIODE UDZSTE-175.6B	
C1219	1-104-666-91	ELECT 220UF	20.00% 25V	D107	8-719-069-55	DIODE UDZSTE-175.6B	
C1221	1-115-339-91	CERAMIC CHIP 0.1UF	10.00% 50V	D207	8-719-069-60	DIODE UDZSTE-179.1B	
C1223	1-163-001-91	CERAMIC CHIP 220PF	10.00% 50V	D210	8-719-069-55	DIODE UDZSTE-175.6B	
C1227	1-163-001-91	CERAMIC CHIP 220PF	10.00% 50V	D211	8-719-069-60	DIODE UDZSTE-179.1B	
C1228	1-126-952-91	ELECT 1000UF	20.00% 35V	D212	8-719-914-43	DIODE DAN202K	
C1229	1-163-001-91	CERAMIC CHIP 220PF	10.00% 50V	D228	8-719-069-55	DIODE UDZSTE-175.6B	
C1230	1-163-001-91	CERAMIC CHIP 220PF	10.00% 50V	D235	8-719-069-55	DIODE UDZSTE-175.6B	
C1235	1-126-960-91	ELECT 1UF	20.00% 50V	D236	8-719-069-60	DIODE UDZSTE-179.1B	
C1236	1-126-960-91	ELECT 1UF	20.00% 50V	D239	8-719-069-60	DIODE UDZSTE-179.1B	
< CONNECTOR >							
CN001	*1-564-508-51	PLUG, CONNECTOR 5P		D402	8-719-081-98	DIODE MM3Z6V8T1	
CN003	*1-564-510-51	PLUG, CONNECTOR 7P		D403	8-719-978-33	DIODE DTZ-TT11-6.8B	
CN501	1-580-798-32	CONNECTOR PIN (DY)		D404	8-719-109-89	DIODE RD5.6ESB2	
CN506	1-695-915-21	TAB (CONTACT)		D405	8-719-081-98	DIODE MM3Z6V8T1	
CN508	*1-564-508-51	PLUG, CONNECTOR 5P		D406	8-719-081-98	DIODE MM3Z6V8T1	
CN601	1-580-843-11	PIN, CONNECTOR (POWER)		D407	8-719-081-98	DIODE MM3Z6V8T1	
CN602	1-508-765-13	PIN, CONNECTOR (5MM PITCH) 3P		D408	8-719-978-33	DIODE DTZ-TT11-6.8B	
CN603	*1-508-786-13	PIN, CONNECTOR (5MM PITCH) 2P		D410	8-719-978-33	DIODE DTZ-TT11-6.8B	
CN604	1-695-915-21	TAB (CONTACT)		D411	8-719-978-33	DIODE DTZ-TT11-6.8B	
CN1201	*1-564-507-51	PLUG, CONNECTOR 4P		D412	8-719-081-98	DIODE MM3Z6V8T1	
< DIODE >							
D001	8-719-069-55	DIODE UDZSTE-175.6B		D413	8-719-978-33	DIODE DTZ-TT11-6.8B	
D002	8-719-069-55	DIODE UDZSTE-175.6B		D414	8-719-081-98	DIODE MM3Z6V8T1	
D003	8-719-109-69	DIODE RD3.6ES-B2		D418	8-719-069-60	DIODE UDZSTE-179.1B	
D004	8-719-302-47	DIODE SEL1210S-D		D419	8-719-049-26	DIODE RB721Q	
D005	8-719-929-15	DIODE HZS9.1NB2		D420	8-719-081-98	DIODE MM3Z6V8T1	
D006	8-719-109-89	DIODE RD5.6ESB2		D421	8-719-049-26	DIODE RB721Q	
D007	8-719-069-55	DIODE UDZSTE-175.6B		D422	8-719-978-33	DIODE DTZ-TT11-6.8B	
D008	8-719-074-43	DIODE BAS316-115		D423	8-719-081-98	DIODE MM3Z6V8T1	
D010	8-719-074-43	DIODE BAS316-115		D424	8-719-069-60	DIODE UDZSTE-179.1B	
D011	8-719-074-43	DIODE BAS316-115		D427	8-719-082-01	DIODE MM3Z12VT1	
D012	8-719-929-15	DIODE HZS9.1NB2		D428	8-719-978-33	DIODE DTZ-TT11-6.8B	
D013	8-719-109-69	DIODE RD3.6ES-B2		D429	8-719-978-33	DIODE DTZ-TT11-6.8B	
D014	1-216-295-91	SHORT 0		D435	8-719-069-60	DIODE UDZSTE-179.1B	
D016	8-719-109-89	DIODE RD5.6ESB2		D436	8-719-069-60	DIODE UDZSTE-179.1B	
D018	8-719-109-69	DIODE RD3.6ES-B2		D501	8-719-908-03	DIODE GP08D	
D019	8-719-978-33	DIODE UDZSTE-176.8B		D502	8-719-081-90	DIODE PDZ22B-115	
D020	8-719-109-89	DIODE RD5.6ESB2		D503	8-719-069-55	DIODE UDZSTE-175.6B	
D021	8-719-978-33	DIODE DTZ-TT11-6.8B		D504	8-719-074-43	DIODE BAS316-115	
D022	8-719-069-55	DIODE UDZSTE-175.6B		D505	8-719-081-97	DIODE MMDL914T1	
D035	8-719-069-55	DIODE UDZSTE-175.6B		D506	8-719-908-03	DIODE GP08D	
D036	8-719-069-55	DIODE UDZSTE-175.6B		D507	8-719-070-59	DIODE PDZ6.8B-115	
D051	8-719-081-98	DIODE MM3Z6V8T1		D512	8-719-302-43	DIODE EL1Z	
D101	8-719-977-81	DIODE DTZ33B		D513	8-719-302-43	DIODE EL1Z	
D103	8-719-081-98	DIODE MM3Z6V8T1		D514	8-719-302-43	DIODE EL1Z	
D104	8-719-069-55	DIODE UDZSTE-175.6B		D534	8-719-908-03	DIODE GP08D	
D105	8-719-069-55	DIODE UDZSTE-175.6B		D535	8-719-908-03	DIODE GP08D	
				D536	8-719-945-80	DIODE ERC06-15S	
				D537	8-719-070-62	DIODE PDZ9.1B-115	
				D538	8-719-908-03	DIODE GP08D	
				D539	8-719-928-08	DIODE ERD28-08S	

A

Note : The components identified by shading and marked Δ are critical for safety. Replace only with the part numbers specified in the parts list.

REF.NO.	PART.NO	DESCRIPTION	REMARK	REF.NO.	PART.NO	DESCRIPTION	REMARK
D541	1-216-295-91	SHORT	0			< IC >	
D573	8-719-082-00	DIODE	MM3Z4V7T1				
D601	8-719-510-53	DIODE	D4SB60L	IC001	8-759-837-20	IC	TDA9394H/N1/4/0310
D602	8-719-911-19	DIODE	1SS119-25	IC002	8-742-180-20	HYB IC	SBX 3081-51(30)
D604	8-719-083-94	DIODE	FUF4005	IC004	8-759-575-72	IC	M24C08-WMN6T
				IC201	6-700-410-01	IC	MSP3410G-PP-B8
D608	8-719-063-70	DIODE	D1NL20U	IC401	8-759-665-11	IC	LM393DT
D610	8-719-110-41	DIODE	RD15ES-B2				
D611	8-719-991-33	DIODE	1SS133T-77	IC501	8-759-339-59	IC	TDA8177
D612	8-719-991-33	DIODE	1SS133T-77	IC531	8-759-665-11	IC	LM393DT
D613	8-719-911-19	DIODE	1SS119-25	IC601	8-759-670-30	IC	MCZ3001D
				IC602	8-749-016-19	IC	SE135N-LF4
D614	8-719-077-76	DIODE	D2SB60A-F04	IC604	8-759-668-87	IC	BA41W12ST-V5
D615	8-719-929-15	DIODE	HZS9.NB2				
D618	8-719-022-97	DIODE	D2S4MTA1	IC608	8-759-591-02	IC	L78L33ABZ-AP
D619	8-719-022-97	DIODE	D2S4MTA1	IC609	8-759-468-89	IC	TOP209P
D620	8-719-109-85	DIODE	RD5.1ESB2	IC1201	8-759-831-57	IC	TDA7495S
D621	8-719-109-89	DIODE	RD5.1ESB2			< JACK >	
D623	8-719-911-19	DIODE	1SS119-25	J401	1-766-296-21	CONNECTOR,	DUAL SCART
D624	8-719-063-70	DIODE	D1NL20U	J402	1-770-329-11	JACK,	PIN 3P
D625	8-719-062-39	DIODE	D4SBL20UF1	J404	1-784-632-11	JACK,	PIN 2P
D627	8-719-063-70	DIODE	D1NL20U	J1200	1-568-267-11	JACK	
D628	8-719-083-49	DIODE	P6KE200ASY			< COIL >	
D629	8-719-083-94	DIODE	FUF4005				
D631	8-719-921-63	DIODE	MTZJ-7.5B	L001	1-408-611-21	INDUCTOR	47UH
D632	8-719-063-70	DIODE	D1NL20U	L003	1-412-006-41	INDUCTOR	10UH
D633	8-719-109-69	DIODE	RD3.6ES-B2	L004	1-408-611-21	INDUCTOR	47UH
D638	8-719-083-92	DIODE	YG802C09RF122	L006	1-408-611-21	INDUCTOR	47UH
D640	8-719-921-63	DIODE	MTZJ-7.5B	L027	1-216-295-91	SHORT	0
D649	8-719-978-33	DIODE	UDZSTE-176.8B	L101	1-412-534-41	INDUCTOR	56UH
D1204	8-719-069-55	DIODE	UDZSTE-175.6B	L102	1-408-611-21	INDUCTOR	47UH
D1205	8-719-081-90	DIODE	PDZ22B-115	L103	1-412-002-41	INDUCTOR	4.7UH
D1230	8-719-074-43	DIODE	BAS316-115	L104	1-412-002-41	INDUCTOR	4.7UH
				L201	1-408-602-21	INDUCTOR	8.2UH
				L202	1-408-591-21	INDUCTOR	1UH
				L203	1-408-602-21	INDUCTOR	8.2UH
F601	Δ 1-576-232-21	FUSE (H.B.C.)	5A/250V	L205	1-408-591-21	INDUCTOR	1UH
	*1-533-725-11	HOLDER, FUSE (F601)		L206	1-535-143-61	LEAD, JUMPER	(5.0MM)
				L207	1-408-591-21	INDUCTOR	1UH
				L401	1-410-993-42	INDUCTOR	1UH
				L403	1-410-993-42	INDUCTOR	1UH
				L404	1-410-993-42	INDUCTOR	1UH
				L405	1-535-143-61	LEAD, JUMPER	(5.0MM)
				L406	1-535-143-61	LEAD, JUMPER	(5.0MM)
FB601	1-410-397-31	FERRITE	1.1UH	L410	1-216-025-91	RES-CHIP	100 5% 1/10W
FB602	1-410-397-31	FERRITE	1.1UH	L430	1-412-002-41	INDUCTOR	4.7UH
FB604	1-410-397-31	FERRITE	1.1UH	L446	1-410-993-42	INDUCTOR	1UH
FB605	1-410-397-31	FERRITE	1.1UH	L448	1-410-993-42	INDUCTOR	1UH
FB606	1-412-911-11	FERRITE	0UH	L501	1-414-187-31	INDUCTOR	47UH
FB607	1-412-911-11	FERRITE	0UH	L502	1-412-531-41	INDUCTOR	33UH
				L503	1-412-521-41	INDUCTOR	4.7UH
						< FILTER >	
FL201	1-239-803-21	FILTER, EMI					

Note : The components identified by shading and marked Δ are critical for safety. Replace only with the part numbers specified in the parts list.

A

REF.NO.	PART.NO	DESCRIPTION	REMARK	REF.NO.	PART.NO	DESCRIPTION	REMARK
L504	1-535-143-61	LEAD, JUMPER (5.0MM)				< RESISTOR >	
L505	1-412-533-41	INDUCTOR 47UH					
L507	1-412-533-41	INDUCTOR 47UH		JR4	1-216-295-91	SHORT	0
L532	1-412-553-41	INDUCTOR 3.3MH		JR7	1-216-295-91	SHORT	0
L533	1-406-989-11	INDUCTOR 10MH		JR9	1-216-295-91	SHORT	0
				JR10	1-216-295-91	SHORT	0
L535	1-459-111-21	INDUCTOR 10MH		JR16	1-216-296-91	SHORT	0
L537	1-419-552-11	COIL, HORIZONTAL LINEARITY					
L538	1-419-263-11	COIL, WITH CORE		JR21	1-216-295-91	SHORT	0
L601	1-408-603-21	INDUCTOR 10UH		JR24	1-216-295-91	SHORT	0
L602	1-408-611-21	INDUCTOR 47UH		JR25	1-216-295-91	SHORT	0
				JR204	1-216-296-91	SHORT	0
L603	1-535-143-61	LEAD, JUMPER (5.0MM)		JR206	1-216-295-91	SHORT	0
L1200	1-535-143-61	LEAD, JUMPER (5.0MM)					
L1201	1-535-143-61	LEAD, JUMPER (5.0MM)		JR209	1-216-295-91	SHORT	0
L1203	1-535-143-61	LEAD, JUMPER (5.0MM)		JR210	1-216-295-91	SHORT	0
				JR211	1-216-296-91	SHORT	0
		< PHOTO COUPLER >		JR213	1-216-295-91	SHORT	0
				JR401	1-216-295-91	SHORT	0
PH601 Δ	8-749-016-21	IC TCET1103G					
		< IC LINK >		JR409	1-216-295-91	SHORT	0
				JR418	1-216-296-91	SHORT	0
PS1201	1-533-597-31	LINK, IC		JR419	1-216-295-91	SHORT	0
		< TRANSISTOR >		JR423	1-216-296-91	SHORT	0
				JR508	1-216-296-91	SHORT	0
Q002	8-729-027-56	TRANSISTOR DTC143TKA-T146					
Q013	8-729-120-28	TRANSISTOR 2SC1623-L5L6		JR516	1-216-296-91	SHORT	0
Q049	8-729-120-28	TRANSISTOR 2SC1623-L5L6		JR517	1-216-296-91	SHORT	0
Q202	8-729-120-28	TRANSISTOR 2SC1623-L5L6		JR601	1-216-295-91	SHORT	0
Q203	8-729-120-28	TRANSISTOR 2SC1623-L5L6		JR609	1-216-295-91	SHORT	0
				JR610	1-216-296-91	SHORT	0
Q212	8-729-422-33	TRANSISTOR 2SD601A-Q-TX		JR1209	1-216-295-91	SHORT	0
Q401	8-729-026-49	TRANSISTOR 2SA1037AK-T146					
Q409	8-729-120-28	TRANSISTOR 2SC1623-L5L6		R003	1-216-065-91	RES-CHIP	4.7K 5% 1/10W
Q411	8-729-120-28	TRANSISTOR 2SC1623-L5L6		R004	1-216-033-91	RES-CHIP	220 5% 1/10W
Q532	8-729-053-33	TRANSISTOR IRF614-037		R005	1-216-041-91	RES-CHIP	470 5% 1/10W
				R006	1-216-025-91	RES-CHIP	100 5% 1/10W
Q533	8-729-051-82	TRANSISTOR BU4508DX-ON5210		R007	1-216-025-91	RES-CHIP	100 5% 1/10W
Q535	8-729-053-33	TRANSISTOR IRF614-037		R008	1-216-025-91	RES-CHIP	100 5% 1/10W
Q601	8-729-026-49	TRANSISTOR 2SA1037AK-T146		R009	1-216-049-91	RES-CHIP	1K 5% 1/10W
Q602	8-729-119-78	TRANSISTOR 2SC2785-HFE		R010	1-216-049-91	RES-CHIP	1K 5% 1/10W
Q603	8-729-029-56	TRANSISTOR DTA144ESA		R011	1-216-295-91	SHORT	0
				R012	1-216-121-91	RES-CHIP	1M 5% 1/10W
Q604	8-729-030-02	TRANSISTOR DTC144ESA					
Q606	8-729-053-36	TRANSISTOR 2SK2640-01MR		R014	1-216-065-91	RES-CHIP	4.7K 5% 1/10W
Q607	8-729-053-36	TRANSISTOR 2SK2640-01MR		R017	1-216-025-91	RES-CHIP	100 5% 1/10W
Q608	8-729-120-28	TRANSISTOR 2SC1623-L5L6		R018	1-208-820-91	METAL CHIP	39K 0.5% 1/10W
Q609	8-729-026-49	TRANSISTOR 2SA1037AK-T146		R020	1-216-077-91	RES-CHIP	15K 5% 1/10W
				R022	1-216-089-91	RES-CHIP	47K 5% 1/10W
Q1210	8-729-120-28	TRANSISTOR 2SC1623-L5L6					
Q1211	8-729-120-28	TRANSISTOR 2SC1623-L5L6		R023	1-216-031-91	RES-CHIP	180 5% 1/10W
Q1230	8-729-027-56	TRANSISTOR DTC143TKA-T146		R024	1-216-025-91	RES-CHIP	100 5% 1/10W
Q1231	8-729-027-56	TRANSISTOR DTC143TKA-T146		R025	1-216-025-91	RES-CHIP	100 5% 1/10W
Q1232	8-729-026-50	TRANSISTOR 2SA1037AK-T146-QR		R026	1-216-025-91	RES-CHIP	100 5% 1/10W
				R027	1-216-025-91	RES-CHIP	100 5% 1/10W
Q1233	8-729-026-50	TRANSISTOR 2SA1037AK-T146-QR					
				R028	1-216-025-91	RES-CHIP	100 5% 1/10W

A

REF.NO.	PART.NO	DESCRIPTION	REMARK	REF.NO.	PART.NO	DESCRIPTION	REMARK
R029	1-216-061-91	RES-CHIP	3.3K 5% 1/10W	R212	1-216-069-91	RES-CHIP	6.8K 5% 1/10W
R030	1-216-821-91	RES-CHIP	1K 5% 1/16W	R213	1-216-081-91	RES-CHIP	22K 5% 1/10W
R031	1-216-061-91	RES-CHIP	3.3K 5% 1/10W	R214	1-216-041-91	RES-CHIP	470 5% 1/10W
R032	1-216-061-91	RES-CHIP	3.3K 5% 1/10W	R215	1-216-037-91	RES-CHIP	330 5% 1/10W
R033	1-216-073-91	RES-CHIP	10K 5% 1/10W	R216	1-216-097-91	RES-CHIP	100K 5% 1/10W
R034	1-216-121-91	RES-CHIP	1M 5% 1/10W	R217	1-216-222-91	RES-CHIP	10K 5% 1/8W
R035	1-216-101-91	RES-CHIP	150K 5% 1/10W	R220	1-216-031-91	RES-CHIP	180 5% 1/10W
R036	1-216-083-91	RES-CHIP	27K 5% 1/10W	R221	1-216-190-91	RES-CHIP	470 5% 1/8W
R039	1-216-065-91	RES-CHIP	4.7K 5% 1/10W	R232	1-216-025-91	RES-CHIP	100 5% 1/10W
R040	1-216-033-91	RES-CHIP	220 5% 1/10W	R233	1-216-069-91	RES-CHIP	6.8K 5% 1/10W
R041	1-216-025-91	RES-CHIP	100 5% 1/10W	R234	1-216-069-91	RES-CHIP	6.8K 5% 1/10W
R042	1-216-025-91	RES-CHIP	100 5% 1/10W	R235	1-216-069-91	RES-CHIP	6.8K 5% 1/10W
R044	1-216-073-91	RES-CHIP	10K 5% 1/10W	R236	1-216-069-91	RES-CHIP	6.8K 5% 1/10W
R045	1-216-025-91	RES-CHIP	100 5% 1/10W	R238	1-216-025-91	RES-CHIP	100 5% 1/10W
R046	1-216-025-91	RES-CHIP	100 5% 1/10W	R246	1-260-107-91	CARBON	4.7K 5% 1/2W
R047	1-216-025-91	RES-CHIP	100 5% 1/10W	R248	1-249-429-91	CARBON	10K 5% 1/4W
R048	1-216-073-91	RES-CHIP	10K 5% 1/10W	R249	1-216-097-91	RES-CHIP	100K 5% 1/10W
R049	1-216-049-91	RES-CHIP	1K 5% 1/10W	R250	1-216-230-91	RES-CHIP	22K 5% 1/8W
R050	1-216-025-91	RES-CHIP	100 5% 1/10W	R251	1-216-069-91	RES-CHIP	6.8K 5% 1/10W
R051	1-216-295-91	SHORT	0	R252	1-216-069-91	RES-CHIP	6.8K 5% 1/10W
R053	1-216-077-91	RES-CHIP	15K 5% 1/10W	R401	1-410-993-42	INDUCTOR	1UH
R055	1-216-025-91	RES-CHIP	100 5% 1/10W	R402	1-216-041-91	RES-CHIP	470 5% 1/10W
R056	1-216-081-91	RES-CHIP	22K 5% 1/10W	R403	1-216-113-91	RES-CHIP	470K 5% 1/10W
R060	1-216-025-91	RES-CHIP	100 5% 1/10W	R404	1-216-113-91	RES-CHIP	470K 5% 1/10W
R061	1-216-025-91	RES-CHIP	100 5% 1/10W	R405	1-216-864-91	SHORT	0
R062	1-216-077-91	RES-CHIP	15K 5% 1/10W	R406	1-216-296-91	SHORT	0
R063	1-216-061-91	RES-CHIP	3.3K 5% 1/10W	R407	1-216-022-91	RES-CHIP	75 5% 1/10W
R064	1-216-069-91	RES-CHIP	6.8K 5% 1/10W	R408	1-216-022-91	RES-CHIP	75 5% 1/10W
R065	1-216-295-91	SHORT	0	R409	1-216-025-91	RES-CHIP	100 5% 1/10W
R066	1-216-053-91	RES-CHIP	1.5K 5% 1/10W	R410	1-216-025-91	RES-CHIP	100 5% 1/10W
R067	1-216-073-91	RES-CHIP	10K 5% 1/10W	R411	1-216-022-91	RES-CHIP	75 5% 1/10W
R070	1-216-025-91	RES-CHIP	100 5% 1/10W	R412	1-216-025-91	RES-CHIP	100 5% 1/10W
R071	1-216-049-91	RES-CHIP	1K 5% 1/10W	R413	1-216-113-91	RES-CHIP	470K 5% 1/10W
R072	1-216-295-91	SHORT	0	R414	1-216-022-91	RES-CHIP	75 5% 1/10W
R074	1-216-073-91	RES-CHIP	10K 5% 1/10W	R415	1-216-022-91	RES-CHIP	75 5% 1/10W
R090	1-216-057-91	RES-CHIP	2.2K 5% 1/10W	R416	1-216-027-91	RES-CHIP	120 5% 1/10W
R092	1-216-073-91	RES-CHIP	10K 5% 1/10W	R417	1-216-113-91	RES-CHIP	470K 5% 1/10W
R094	1-216-025-91	RES-CHIP	100 5% 1/10W	R418	1-216-113-91	RES-CHIP	470K 5% 1/10W
R095	1-216-065-91	RES-CHIP	4.7K 5% 1/10W	R419	1-216-022-91	RES-CHIP	75 5% 1/10W
R096	1-216-025-91	RES-CHIP	100 5% 1/10W	R420	1-216-073-91	RES-CHIP	10K 5% 1/10W
R101	1-216-093-91	RES-CHIP	68K 5% 1/10W	R421	1-216-049-91	RES-CHIP	1K 5% 1/10W
R102	1-216-097-91	RES-CHIP	100K 5% 1/10W	R422	1-216-864-91	SHORT	0
R104	1-216-295-91	SHORT	0	R423	1-216-113-91	RES-CHIP	470K 5% 1/10W
R105	1-414-813-21	INDUCTOR	0UH	R424	1-216-113-91	RES-CHIP	470K 5% 1/10W
R106	1-215-900-51	METAL OXIDE	22K 5% 2W	R425	1-216-085-91	RES-CHIP	33K 5% 1/10W
R107	1-216-025-91	RES-CHIP	100 5% 1/10W	R426	1-216-073-91	RES-CHIP	10K 5% 1/10W
R108	1-216-025-91	RES-CHIP	100 5% 1/10W	R427	1-216-113-91	RES-CHIP	470K 5% 1/10W
R201	1-216-025-91	RES-CHIP	100 5% 1/10W	R428	1-216-073-91	RES-CHIP	10K 5% 1/10W
R202	1-216-073-91	RES-CHIP	10K 5% 1/10W	R429	1-216-089-91	RES-CHIP	47K 5% 1/10W
R211	1-216-081-91	RES-CHIP	22K 5% 1/10W	R430	1-216-073-91	RES-CHIP	10K 5% 1/10W

Note : The components identified by shading and marked Δ are critical for safety. Replace only with the part numbers specified in the parts list.

A

REF.NO.	PART.NO	DESCRIPTION	REMARK	REF.NO.	PART.NO	DESCRIPTION	REMARK
R431	1-216-073-91	RES-CHIP	10K 5% 1/10W	R532	1-216-085-91	RES-CHIP	33K 5% 1/10W
R433	1-216-073-91	RES-CHIP	10K 5% 1/10W	R533	1-216-081-91	RES-CHIP	22K 5% 1/10W
R434	1-216-073-91	RES-CHIP	10K 5% 1/10W	R534	1-216-117-91	RES-CHIP	680K 5% 1/10W
R435	1-216-295-91	SHORT	0	R535	1-216-097-91	RES-CHIP	100K 5% 1/10W
R438	1-216-022-91	RES-CHIP	75 5% 1/10W	R538	1-535-143-71	LEAD, JUMPER (7.5MM)	
R439	1-216-022-91	RES-CHIP	75 5% 1/10W	R539	1-215-892-81	METAL OXIDE	1K 5% 2W
R440	1-216-049-91	RES-CHIP	1K 5% 1/10W	R540	1-215-887-21	METAL OXIDE	150 5% 2W
R441	1-216-051-91	RES-CHIP	1.2K 5% 1/10W	R542	1-216-121-91	RES-CHIP	1M 5% 1/10W
R442	1-216-085-91	RES-CHIP	33K 5% 1/10W	R543	1-216-065-91	RES-CHIP	4.7K 5% 1/10W
R443	1-216-073-91	RES-CHIP	10K 5% 1/10W	R544	1-216-103-91	RES-CHIP	180K 5% 1/10W
R444	1-216-061-91	RES-CHIP	3.3K 5% 1/10W	R545	1-216-129-91	RES-CHIP	2.2M 5% 1/10W
R446	1-216-113-91	RES-CHIP	470K 5% 1/10W	R546	1-215-920-51	METAL OXIDE	3.3K 5% 3W
R447	1-216-295-91	SHORT	0	R547	1-215-886-21	METAL OXIDE	100 5% 2W
R448	1-216-113-91	RES-CHIP	470K 5% 1/10W	R548	1-212-849-61	FUSIBLE	4.7 5% 1/4W
R449	1-216-295-91	SHORT	0	R549	1-216-369-21	METAL OXIDE	1 5% 2W
R450	1-216-041-91	RES-CHIP	470 5% 1/10W	R551	1-215-873-21	METAL OXIDE	4.7K 5% 1W
R451	1-216-041-91	RES-CHIP	470 5% 1/10W	R552	1-216-848-91	RES-CHIP	180K 5% 1/16W
R453	1-216-171-91	RES-CHIP	75 5% 1/8W	R553	1-249-381-91	CARBON	1 5% 1/4W
R454	1-216-001-91	RES-CHIP	10 5% 1/10W	R554	1-216-105-91	RES-CHIP	220K 5% 1/10W
R455	1-216-295-91	SHORT	0	R556	1-215-920-51	METAL OXIDE	3.3K 5% 3W
R460	1-216-049-91	RES-CHIP	1K 5% 1/10W	R557	1-216-065-91	RES-CHIP	4.7K 5% 1/10W
R461	1-216-022-91	RES-CHIP	75 5% 1/10W	R558	1-216-025-91	RES-CHIP	100 5% 1/10W
R462	1-216-029-91	RES-CHIP	150 5% 1/10W	R559	1-249-428-91	CARBON	8.2K 5% 1/4W
R501	1-216-091-91	RES-CHIP	56K 5% 1/10W	R560	1-249-429-91	CARBON	10K 5% 1/4W
R502	1-216-073-91	RES-CHIP	10K 5% 1/10W	R561	1-216-129-91	RES-CHIP	2.2M 5% 1/10W
R503	1-215-888-21	METAL OXIDE	220 5% 2W	R562	1-216-117-91	RES-CHIP	680K 5% 1/10W
R504	1-249-385-91	CARBON	2.2 5% 1/4W	R565	1-216-049-91	RES-CHIP	1K 5% 1/10W
R505	1-216-677-91	METAL CHIP	12K 0.5% 1/10W	R568	1-215-920-51	METAL OXIDE	3.3K 5% 3W
R506	1-208-796-91	METAL CHIP	3.9K 0.5% 1/10W	R583	1-216-081-91	RES-CHIP	22K 5% 1/10W
R507	1-216-349-51	METAL OXIDE	1 5% 1W	R589	1-216-295-91	SHORT	0
R508	1-216-677-91	METAL CHIP	12K 0.5% 1/10W	R591	1-215-892-51	METAL OXIDE	1K 5% 2W
R509	1-208-796-91	METAL CHIP	3.9K 0.5% 1/10W	R595	1-249-377-91	CARBON	0.47 5% 1/4W
R510	1-216-113-91	RES-CHIP	470K 5% 1/10W	R600	1-211-964-91	METAL CHIP	33 0.5% 1/10W
R512	1-249-382-91	CARBON	1.2 5% 1/4W	R601	1-208-776-91	METAL CHIP	560 0.5% 1/10W
R514	1-249-377-91	CARBON	0.47 5% 1/4W	R602	1-202-962-11	CEMENTED	3.3 5% 10W
R515	1-249-377-91	CARBON	0.47 5% 1/4W	R603	1-220-926-21	FUSIBLE	0.47 10% 1/2W
R516	1-214-907-81	METAL	56K 1% 1/2W	R605	1-216-049-91	RES-CHIP	1K 5% 1/10W
R517	1-215-461-91	METAL	47K 1% 1/4W	R606	Δ 1-202-719-91	SOLID	1M 10% 1/2W
R518	1-216-059-91	RES-CHIP	2.7K 5% 1/10W	R608	1-216-073-91	RES-CHIP	10K 5% 1/10W
R519	1-216-129-91	RES-CHIP	2.2M 5% 1/10W	R609	1-216-677-91	METAL CHIP	12K 0.5% 1/10W
R520	1-215-883-21	METAL OXIDE	33 5% 2W	R610	1-215-481-91	METAL	330K 1% 1/4W
R523	1-216-117-91	RES-CHIP	680K 5% 1/10W	R611	1-216-059-91	RES-CHIP	2.7K 5% 1/10W
R524	1-216-083-91	RES-CHIP	27K 5% 1/10W	R612	1-249-429-91	CARBON	10K 5% 1/4W
R525	1-216-057-91	RES-CHIP	2.2K 5% 1/10W	R613	Δ 1-219-720-91	METAL	8.2M 5% 1W
R526	1-216-089-91	RES-CHIP	47K 5% 1/10W	R615	1-215-385-91	METAL	33 1% 1/4W
R527	1-216-079-91	RES-CHIP	18K 5% 1/10W	R618	1-247-889-91	CARBON	270K 5% 1/4W
R528	1-216-097-91	RES-CHIP	100K 5% 1/10W	R619	1-216-065-91	RES-CHIP	4.7K 5% 1/10W
R529	1-216-073-91	RES-CHIP	10K 5% 1/10W	R621	1-216-113-91	RES-CHIP	470K 5% 1/10W
R530	1-216-085-91	RES-CHIP	33K 5% 1/10W	R622	1-216-073-91	RES-CHIP	10K 5% 1/10W
R531	1-216-057-91	RES-CHIP	2.2K 5% 1/10W	R623	1-216-081-91	RES-CHIP	22K 5% 1/10W

A **C**

Note : The components identified by shading and marked Δ are critical for safety. Replace only with the part numbers specified in the parts list.

REF.NO.	PART.NO	DESCRIPTION	REMARK
R624	1-216-001-91	RES-CHIP	10 5% 1/10W
R625	1-216-073-91	RES-CHIP	10K 5% 1/10W
R627	1-249-389-91	CARBON	4.7 5% 1/4W
R628	1-247-791-91	CARBON	22 5% 1/4W
R629	1-216-073-91	RES-CHIP	10K 5% 1/10W
R632	1-249-417-91	CARBON	1K 5% 1/4W
R633	1-215-481-91	METAL	330K 1% 1/4W
R634	1-217-625-11	METAL	0.05 10% 2W
R635	1-260-300-71	CARBON	4.7 5% 1/2W
R636	1-249-413-91	CARBON	470 5% 1/4W
R637	1-216-041-91	RES-CHIP	470 5% 1/10W
R639	1-208-814-91	METAL CHIP	22K 0.5% 1/10W
R640	1-208-830-91	METAL CHIP	100K 0.5% 1/10W
R641	1-216-097-91	RES-CHIP	100K 5% 1/10W
R642	1-249-405-91	CARBON	100 5% 1/4W
R643	1-216-089-91	RES-CHIP	47K 5% 1/10W
R645	1-216-073-91	RES-CHIP	10K 5% 1/10W
R647	1-216-049-91	RES-CHIP	1K 5% 1/10W
R648	1-215-481-91	METAL	330K 1% 1/4W
R649	1-208-805-91	METAL CHIP	9.1K 0.5% 1/10W
R650	1-208-758-91	METAL CHIP	100 0.5% 1/10W
R651	1-220-926-21	FUSIBLE	0.47 10% 1/2W
R652	1-216-081-91	RES-CHIP	22K 5% 1/10W
R653	1-216-073-91	RES-CHIP	10K 5% 1/10W
R654	1-216-001-91	RES-CHIP	10 5% 1/10W
R656	1-216-365-51	METAL OXIDE	0.47 5% 2W
R660	1-247-807-91	CARBON	100 5% 1/4W
R1200	1-260-093-81	CARBON	330 5% 1/2W
R1201	1-260-093-81	CARBON	330 5% 1/2W
R1207	1-216-077-91	RES-CHIP	15K 5% 1/10W
R1208	1-216-067-91	RES-CHIP	5.6K 5% 1/10W
R1209	1-216-073-91	RES-CHIP	10K 5% 1/10W
R1210	1-216-077-91	RES-CHIP	15K 5% 1/10W
R1211	1-216-049-91	RES-CHIP	1K 5% 1/10W
R1212	1-216-057-91	RES-CHIP	2.2K 5% 1/10W
R1213	1-216-049-91	RES-CHIP	1K 5% 1/10W
R1214	1-216-049-91	RES-CHIP	1K 5% 1/10W
R1215	1-216-049-91	RES-CHIP	1K 5% 1/10W
R1230	1-216-041-91	RES-CHIP	470 5% 1/10W
R1231	1-216-113-91	RES-CHIP	470K 5% 1/10W
R1232	1-216-041-91	RES-CHIP	470 5% 1/10W
R1233	1-216-113-91	RES-CHIP	470K 5% 1/10W
R1235	1-216-073-91	RES-CHIP	10K 5% 1/10W
R1236	1-216-073-91	RES-CHIP	10K 5% 1/10W
< RELAY >			
RY601	1-755-388-91	RELAY (AC POWER)	

REF.NO.	PART.NO	DESCRIPTION	REMARK
< SWITCH >			
S001	1-692-431-21	SWITCH, TACTIL	
S002	1-692-431-21	SWITCH, TACTIL	
S003	1-692-431-21	SWITCH, TACTIL	
S004	1-692-431-21	SWITCH, TACTIL	
S005	1-692-431-21	SWITCH, TACTIL	
S006	1-692-431-21	SWITCH, TACTIL	
S601	Δ 1-571-433-31	SWITCH, PUSH (AC POWER)	
SW532	1-572-707-21	SWITCH, LEVER	
< TRANSFORMER >			
T511	Δ 1-453-314-31	TRANSFORMER ASSY, FLYBACK	
T531	1-437-210-21	TRANSFORMER, HORIZONTAL DRIVE	
T601	Δ 1-427-962-11	TRANSFORMER, LINE FILTER	
T602	Δ 1-431-732-31	TRANSFORMER, CONVERTER (SRT)	
T603	Δ 1-435-976-11	TRANSFORMER, CONVERTER (PIT)	
< THERMISTOR >			
TH601	1-803-586-41	THERMISTOR	
THP601	Δ 1-803-951-11	THERMISTOR, PTC	
< VARISTOR >			
VDR601	1-803-830-31	VARISTOR (ERZV14D621)	
< CRYSTAL >			
X001	1-578-774-71	VIBRATOR, CRYSTAL	
X201	1-760-628-21	VIBRATOR, CRYSTAL	
A Board Variant Parts KV-21FX30			
< TUNER >			
TU101	8-598-535-10	FRONTEND BTF-EF411 (KV-21FX30B)	
	8-598-533-00	FRONTEND BTF-EC411 (KV-21FX30E/21FX30K)	
*A-1639-020-A C Board, Complete			
	4-382-854-01	SCREW (M3X8), P, SW (+)	
	4-382-854-01	SCREW (M3X8), P, SW (+)	
< CAPACITOR >			
C701	1-136-189-91	MYLAR	0.1UF 10.00% 250V
C702	1-126-964-91	ELECT	10UF 20.00% 50V
C703	1-101-004-91	CERAMIC	0.01UF 50V
C708	1-162-114-51	CERAMIC	0.0047UF 2KV
C710	1-107-957-91	ELECT	1UF 20.00% 250V
C1803	1-101-005-91	CERAMIC	0.022UF 50V
C1804	1-126-964-91	ELECT	10UF 20.00% 50V
C1805	1-101-880-91	CERAMIC	47PF 5.00% 50V

Note : The components identified by shading and marked Δ are critical for safety. Replace only with the part numbers specified in the parts list.

C

REF.NO.	PART.NO	DESCRIPTION	REMARK	REF.NO.	PART.NO	DESCRIPTION	REMARK
		< CONNECTOR >		R1808	1-249-429-91	CARBON 10K 5% 1/4W	
				R1809	1-249-429-91	CARBON 10K 5% 1/4W	
				R1810	1-249-429-91	CARBON 10K 5% 1/4W	
CN702	1-695-915-21	TAB (CONTACT)					
CN703	*1-564-510-51	PLUG, CONNECTOR 7P					
CN706	1-695-915-21	TAB (CONTACT)					
CN707	*1-564-508-51	PLUG, CONNECTOR 5P					
CN1801	*1-564-506-51	PLUG, CONNECTOR 3P					
		< DIODE >					
D701	8-719-991-33	DIODE 1SS133T-77					
D702	8-719-901-83	DIODE 1SS83					
D704	8-719-110-41	DIODE RD15ES-B2					
D705	8-719-302-43	DIODE EL1Z					
D706	8-719-901-83	DIODE 1SS83					
D707	8-719-901-83	DIODE 1SS83					
D708	8-719-109-97	DIODE RD6.8ES-B2					
D709	8-719-109-97	DIODE RD6.8ES-B2					
D710	8-719-109-97	DIODE RD6.8ES-B2					
D1801	8-719-048-53	MTZJ-T-72-10B					
D1802	8-719-048-53	MTZJ-T-72-10B					
D1803	8-719-048-53	MTZJ-T-72-10B					
		< IC >					
IC701	8-759-491-92	IC TDA6107Q-N1					
IC1801	8-759-603-37	IC M5216P					
		< SOCKET >					
J701	Δ 1-251-595-11	SOCKET, CRT					
		< COIL >					
L704	1-414-183-31	INDUCTOR 10UH					
		< RESISTOR >					
R701	1-247-903-91	CARBON 1M 5% 1/4W					
R702	1-249-429-91	CARBON 10K 5% 1/4W					
R703	1-535-143-61	LEAD, JUMPER (5.0MM)					
R704	1-216-372-51	METAL OXIDE 1.8 5% 2W					
R705	1-215-869-21	METAL OXIDE 1K 5% 1W					
R706	1-249-411-91	CARBON 330 5% 1/4W					
R712	1-215-869-21	METAL OXIDE 1K 5% 1W					
R716	1-249-411-91	CARBON 330 5% 1/4W					
R718	1-202-814-91	SOLID 33K 10% 1/2W					
R726	1-215-869-21	METAL OXIDE 1K 5% 1W					
R727	1-249-411-91	CARBON 330 5% 1/4W					
R741	1-202-549-81	SOLID 100 20% 1/2W					
R1801	1-249-441-91	CARBON 100K 5% 1/4W					
R1805	1-249-429-91	CARBON 10K 5% 1/4W					
R1806	1-247-899-91	CARBON 680K 5% 1/4W					
R1807	1-249-429-91	CARBON 10K 5% 1/4W					

Note : The components identified by shading and marked Δ are critical for safety. Replace only with the part numbers specified in the parts list.

REF.NO.	PART.NO	DESCRIPTION	REMARK	REF.NO.	PART.NO	DESCRIPTION	REMARK
MISCELLANEOUS							
	Δ 1-571-433-31	SWITCH, PUSH (AC POWER)					
	Δ 1-765-286-11	CORD, POWER					
	Δ 1-453-314-31	TRANSFORMER ASSY, FLYBACK					
	8-598-535-10	FRONTEND (BTF-EF411) (KV-21FX30B)					
	8-598-533-00	FRONTEND (BTF-EC411) (KV-21FX30E/21FX30K)					
	1-505-924-11	SPEAKER (15X6.5CM)					
	Δ 8-738-836-05	PICTURE TUBE (A51LPT60X)					
	8-451-505-41	DEFLECTION YOKE (Y21RSA-L)					
	1-452-728-61	COIL, NA ROTATION (RT-154)					
	Δ 1-419-772-11	COIL DEGAUSSING					
	Δ 1-251-839-21	CAP ASSY, HIGH VOLTAGE					
	1-452-094-11	MAGNET, ROTATABLE DISK; 15MM \emptyset					
	1-452-032-11	MAGNET, DISK; 10MM \emptyset					
ACCESSORIES AND PACKAGING MATERIALS							
	4-206-090-21	INSTRUCTION MANUAL (KV-21FX30B) (GERMAN/FRENCH/ITALIAN/DUTCH)					
	4-206-090-11	INSTRUCTION MANUAL (KV-21FX30E) (GERMAN/GREEK/TURKISH)					
	4-206-090-41	INSTRUCTION MANUAL (KV-21FX30E) (ITALIAN)					
	4-206-090-51	INSTRUCTION MANUAL (KV-21FX30E) (DANISH/SPANISH/NORWEGIAN/PORTUGUESE/ SWEDISH/FINNISH)					
	4-206-090-31	INSTRUCTION MANUAL (KV-21FX30K) (BULGARIAN/CZECH/ENGLISH/HUNGARIAN/ POLISH/RUSSIAN)					
	*4-039-905-11	BAG, PROTECTION					
	*4-206-068-01	INDIVIDUAL CARTON					
REMOTE COMMANDER							
	1-418-476-21	COMMANDER, STANDARD (RM-887)					

TRACE

A new TV Repair Assistance Tool that combines ease of use and powerful PC software tools to allow you to save valuable time during many TV repairs.



The TRACE interface connects to the PC's serial port. It provides connection to the TV's I²C bus and can be provided with an InfraRed transmitter (optional).

The interface is powered by a standard 9 V PP3 battery for portable use, and can also be powered by an external 9V/25mA DC power supply.

The TRACE software that is supplied with the interface allows you to:

- Read, restore and compare NVM contents via the I²C bus
- Acknowledge check of all I²C devices in the TV set
- Read Error Codes (emulation of the Error Reader tool)

With the optional IR Add-on kit, the following features can be added:

- Remote Commander emulation
- User programmable Functional Check through Infrared
- Fast and documented Test Mode setting of all Sony TV chassis

Additional features such as Adjustments and Troubleshooting are available in chassis-dependent software modules. Please contact your local Sony Service organisation for the latest information.

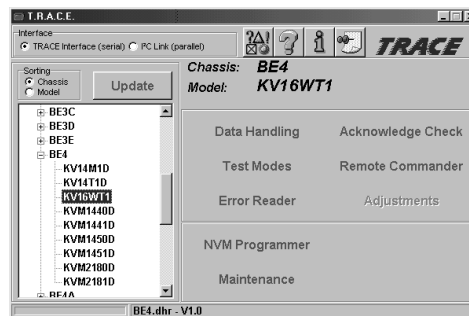

Note: For workshops already using the existing I²C Link parallel port interface (9-948-320-30), this software can be used as well, replacing the TV Data Handling software (9-948-340-50), but Error Reader and IR functions can only be accessed with the TRACE interface.

Partnumbers: TRACE Starter Kit (TRACE interface + software): 9-948-320-70
TRACE Software (for users of the I²C Link interface): 9-948-340-80
TRACE IR Add-on (IR interface + Remote Commander software): 9-948-320-80

PC requirements: IBM-compatible PC with operating system Windows95, Windows98, or WindowsNT*.

* WindowsNT only supported with TRACE interface